

The AAPM/RSNA Physics Tutorial for Residents

CME FEATURE

This article meets the criteria for 1.0 credit hour in Category 1 of the AMA Physician's Recognition Award. To obtain credit, see the questionnaire at the end of the article.

Contrast Mechanisms in Spin-Echo MR Imaging¹

Donald B. Plewes, PhD

The majority of sequences used in routine clinical magnetic resonance imaging rely on the concepts involving the spin echo. Spin-echo sequences require long acquisition times (1-10 minutes), but compared with faster gradient-recalled echo methods, spin-echo methods are relatively immune to signal loss and distortions from field inhomogeneity and tissue-induced susceptibility variations. Through modifications of intersequence repetition time (TR), echo formation interval (echo time [TE]), and various gradient moments, image contrast can be altered to emphasize tissue relaxation times T1, T2, or proton density. The TR and TE values control the amount of T1 weighting and T2 weighting, respectively. At long TR intervals (approximately 10 × tissue T1 values) and minimum TE values, the difference in signal intensity arising from relaxation vanishes, and contrast arises solely from the differences in proton density between the two tissues. Images formed with short TR intervals and long TE values exhibit very low signal-to-noise ratio and negligible contrast and should be avoided. Recently, fast spin-echo sequences have partially overcome the limitation of long acquisition times, with up to 16-fold reduction, by acquiring multiple lines in k space with multiecho sequences.

■ INTRODUCTION

Contrast mechanisms in magnetic resonance (MR) imaging are plentiful. Unlike computed tomography, which relies on the differences in the x-ray attenuation coefficients of various tissues, MR signals of biologic tissues can be influenced by multiple mechanisms and strongly depend on the pulse sequence used. Many MR pulse sequences have been developed that are capable of probing a broad array of diverse physical properties, including molecular dynamics, relaxation phenomena, magnetization exchange rates, diffusion, magnetic properties of tissue, chemical sensitivity, and motion. However, in routine clinical applications, the vast majority of imaging procedures rely on

Abbreviations: TE = echo time, TR = repetition time

Index terms: Magnetic resonance (MR), physics • Magnetic resonance (MR), pulse sequences • Magnetic resonance (MR), rapid imaging

RadioGraphics 1994; 14:1389-1404

¹ From the Department of Medical Biophysics, University of Toronto Sunnybrook Health Science Centre, 2075 Bayview Ave, Toronto, Ontario, Canada M4N 3M5. From the RSNA/AAPM Physics Tutorial at the 1993 RSNA scientific assembly. Received June 9, 1994; revision requested July 25 and received September 22; accepted October 4. **Address reprint requests to the author.**

© RSNA, 1994

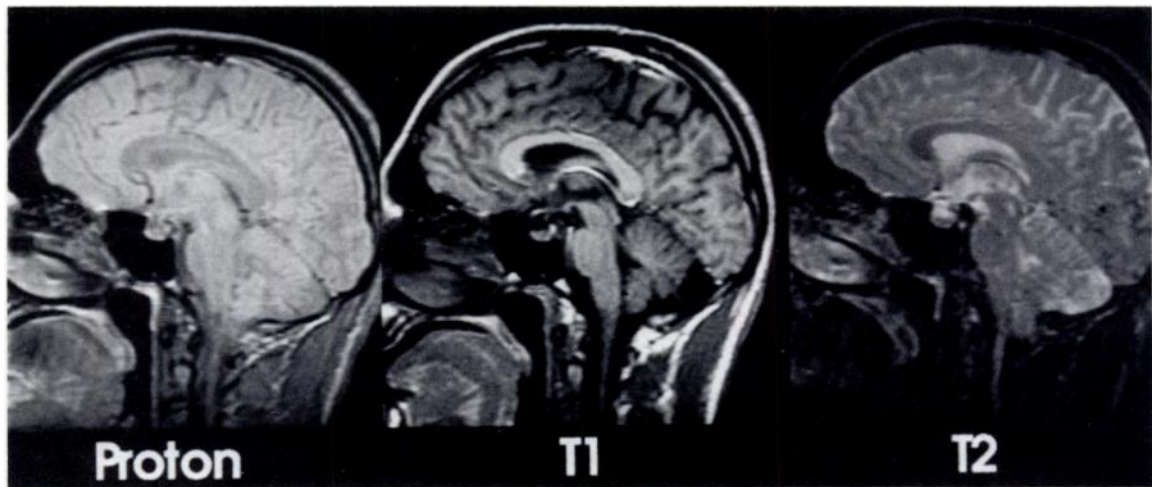

Figure 1. Sagittal spin-echo images of the head demonstrate the proton density, T1-weighted, and T2-weighted tissue variations. The three images show large variations in contrast for normal anatomy and provide three different vantage points from which to assess various pathologic conditions.

relatively simple imaging protocols that restrict the mechanisms of contrast formation to proton density and relaxation effects. Although gradient-recalled sequences are gaining in their breadth of application, the bulk of routine clinical imaging involves variants of spin-echo sequences.

This article presents the basic physics of contrast formation in the spin-echo sequence and reviews the role of various timing factors that are used to manipulate image contrast. The notion of k space, which describes how acquired data are organized, is introduced. In addition, the fast spin-echo method that has recently been developed to overcome the long spin-echo acquisition times is discussed, and its contrast properties and limitations are reviewed in comparison to conventional spin-echo imaging.

■ RELAXATION EFFECTS

The primary factors providing image contrast in spin-echo MR imaging are proton density, spin-lattice or longitudinal relaxation (T1), and spin-spin or transverse relaxation (T2). Although image brightness modulations from proton density are present in all MR images, contrast can be adjusted further by manipulating the timing param-

eters in the spin-echo sequence to illustrate tissue differences in relaxation properties. Figure 1 illustrates these effects with images in which contrast largely depends on proton density, T1, and T2 distributions throughout the head. To appreciate the details of how image contrast is formed in each of these cases, one must be familiar with the nature of common relaxation mechanisms in proton MR imaging.

● Spin-Lattice Relaxation

MR signals arise from the manipulation of magnetization that results from polarized hydrogen nuclei in a static magnetic field. The size of this equilibrium magnetization (M_0) primarily depends on the strength of the applied magnetic field and the proton density. In the equilibrium condition, magnetization is aligned parallel to the applied magnet field B_0 . Radio-frequency pulses can be used to excite the protons, which in turn can be understood as manipulations in the direction and magnitude of the magnetization. Spin-lattice relaxation is a process that is responsible for the dissipation of energy from these excited protons into their molecular environment or the "lattice" (Fig 2).

Initially, the magnetization is oriented parallel to the applied magnetic field. A 90° radio-frequency pulse causes the magnetization to be tipped into the x-y or "transverse" plane and re-

■ THE HAHN OR SPIN ECHO

The concept of spin echoes was originally introduced in 1950 by Hahn (1) only 4 years after the first experimental demonstrations of nuclear MR (2,3). The spin-echo technique is composed of two radio-frequency pulses, with the first pulse being a 90° excitation to tip longitudinal magnetization into the transverse plane, followed by a 180° "refocusing" pulse to form an echo (Fig 3). A string of 180° pulses can be used, forming a Carr-Purcell-Meiboom-Gill (CPMG) sequence (4,5) that results in a gradual reduction in echo amplitude with each echo (Fig 4). This signal decay is due solely to spin-spin relaxation. The time for the echo amplitudes to decay to 37% of their initial magnetization is the T2 time.

● Typical Relaxation Times

Typical values for relaxation times and proton densities (6) (normalized to that of cerebrospinal fluid) for a range of tissues in the head when imaged at 1.5 T (7) are given in the Table. These data are approximate and have considerable intra- and interpatient variability (8). Nevertheless, they illustrate the general trend seen in many cellular tissues: Tissues with high T1 values also tend to exhibit long T2 values and frequently elevated proton densities.

This trend may not be seen in tissues that contain iron in the form of deoxyhemoglobin and methemoglobin, which influence the proton relaxation rates (9,10). Lesions in the brain tend to exhibit longer T1 and T2 relaxation times than do their counterparts in parenchymal tissues; however, exceptions do occur (6). Most white matter lesions have increased proton density, which correlates with increased relaxation times (6). The relative differences in T1, T2, and proton density for white and gray matter are 33%, 13%, and 12%, respectively. This shows that large intrinsic contrasts are available for imaging, and typically the contrast between a lesion, accompanying brain edema, and surrounding tissue is large.

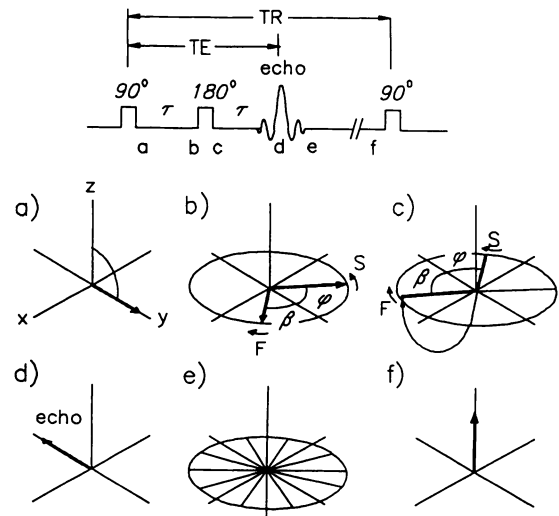

Figure 3. Mechanism of a spin echo. Diagrams a), b), c), d), e), and f) show the state of the magnetization at various times (a-f) during a spin-echo pulse sequence (top). TE = echo time, TR = repetition time. At time a, immediately after the 90° pulse, the magnetization exhibits coherence and is detectable as a net transverse magnetization. Because of variations in local magnetic field over the sample and spin interactions, nuclei at different locations experience different fields and accordingly precess at different Larmor frequencies. Consider two nuclei that rotate slightly faster (F) or slower (S) than the rotating frame. After τ seconds (time b), nuclei F and S will have accumulated a phase angle of β and ϕ , respectively. The second radio-frequency pulse rotates these two vectors about the x axis by 180° to place F and S in their mirror positions (about the x axis) at time c and negates their respective y components. Most important, the two vectors now have the same angular relation to the negative y axis after the inverting pulse as they exhibited to the positive y axis before the inverting pulse, and they continue to drift in the same direction. Thus, during the next τ seconds after the refocusing pulse, nuclei F and S will precess another β and ϕ radians to become aligned along the negative y axis to form an echo or an increase in transverse magnetization and signal at TE. By this means, signal decay arising from constant variations in magnetic field is removed and any difference in echo amplitude is due solely to T2 effects. At some later time e, the nuclei will have again dephased and all transverse signal will be lost. At this point, a second 180° pulse could be applied to form a second echo.

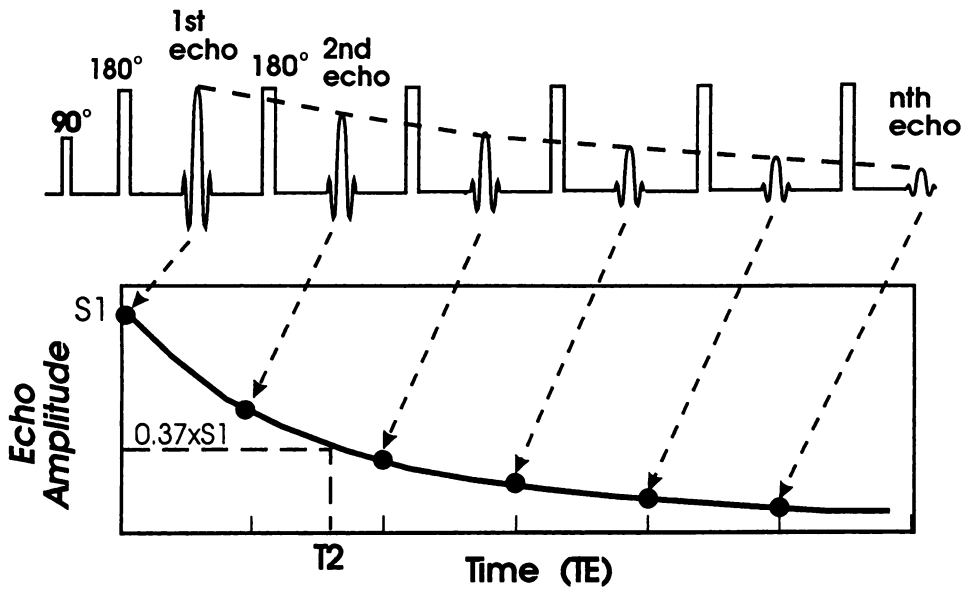

Figure 4. Diagram plots several echoes and the pulse sequence used for the measurement of the T2 relaxation time. The T2 relaxation time is the time required for the spin-echo amplitude to decay to 37% of its maximum value ($S1$).

Relaxation Times and Proton Densities at 1.5 T			
Tissue	T1 (msec)	T2 (msec)	Proton Density
White matter	510	67	0.61
Gray matter	760	77	0.69
Edema	900	126	0.86
Cerebrospinal fluid	2,650	280	1.00

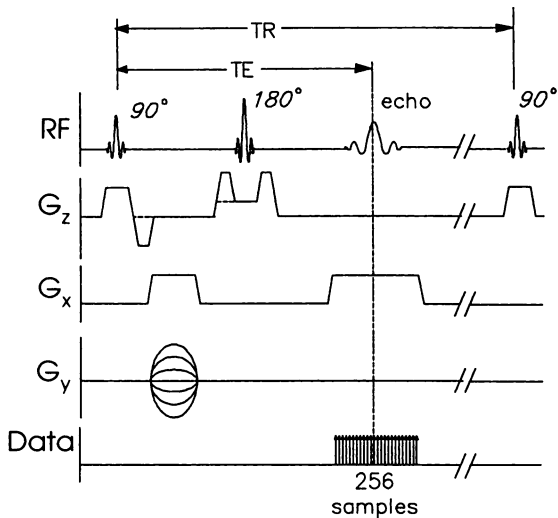

Figure 5. Diagram depicts a pulse sequence for a spin-echo imaging sequence. G_x , G_y , G_z = magnetic field gradients in the x, y, and z directions, RF = radio frequency.

● Spin-Echo Imaging Sequence

The pulse sequence diagram for a spin-echo imaging sequence is shown in Figure 5. The sequence is similar to the spin-echo sequence previously described and is composed of a series of selective 90° and 180° pulses that generate a spin echo at a specified time (TE) after the initial 90° pulse. This sequence is repeated at a specified interval (TR). Both TR and TE are adjustable and provide the main means whereby image contrast can be manipulated. TR is generally chosen to range from 300 to 3,000 msec, whereas TE is chosen to be within 15-300 msec.

The transverse magnetization is measured in the presence of a readout (G_x) gradient, during which time many samples (N_x) are taken. Usu-

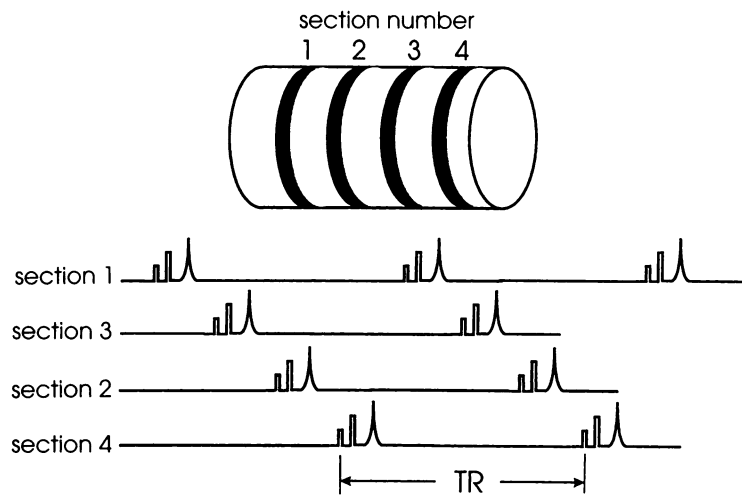

Figure 6. Diagram illustrates the interleaving principle of multisection MR imaging acquisition.

ally, 256 data samples are taken; however, fewer samples can be acquired in fractional echo acquisitions. The application of the readout gradient provides spatial localization in the x direction through frequency encoding. Spatial localization in the y direction is achieved by applying a variable phase-encoding (G_y) gradient, which is incremented with each TR interval. If N_y rows of pixels are desired in the phase-encoding direction, G_y is usually incremented at least N_y times. However, as the k-space data exhibit certain symmetry properties, only slightly more than half as many phase-encoding views may be required, which allows a substantial reduction in acquisition or scan time.

Often, improving the signal-to-noise ratio in an image is desired and can be achieved by averaging a number of identically phase-encoded measurements (ie, number of signals averaged [NSA]). The net result of these repeated pulse sequences is an overall acquisition time equal to $N_y \cdot NSA \cdot TR$.

● Multisection Imaging

As described, the spin-echo sequence can generate a single section in the acquisition time T_s . For example, the parameters of $NSA = 1$, $N_y = 256$ phase-encoding views, and $TR = 2,000$ msec translate into an acquisition time of 8.5 minutes. The obvious limitation of this approach is that it must be repeated for each desired section location. This limitation is eliminated by use of a multisection technique that all commercial MR imaging systems employ, which allows a dramatic increase in the number of sections acquired (Fig 6). During the long TR

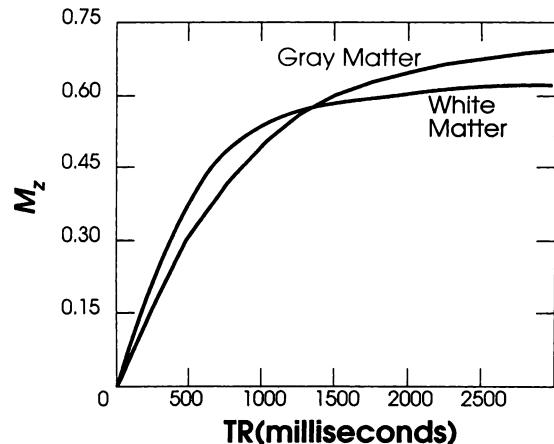

Figure 7. Diagram shows the magnitude of longitudinal magnetization (M_z) from gray and white matter plotted as a function of TR from the data in the Table, with a TE of zero.

interval after the spin echo has occurred, there remains a considerable period during which additional sections can be interleaved from other locations (11). Thus, because the TE interval is much shorter than the TR interval, many sections can be acquired simultaneously.

In principle, each section is spatially selective, and sections do not interfere with each other. However, in practice, the quality of the selective pulses is less than ideal and adjacent sections can influence each other, leading to degraded contrast. A simple approach for overcoming this limitation is to collect spatially alternate sections in temporal succession, thus minimizing the likelihood of interference. Alternatively, providing a small gap between sections further reduces contrast degradation. By this means, the number of sections that can be acquired is approximately equal to TR/TE , and

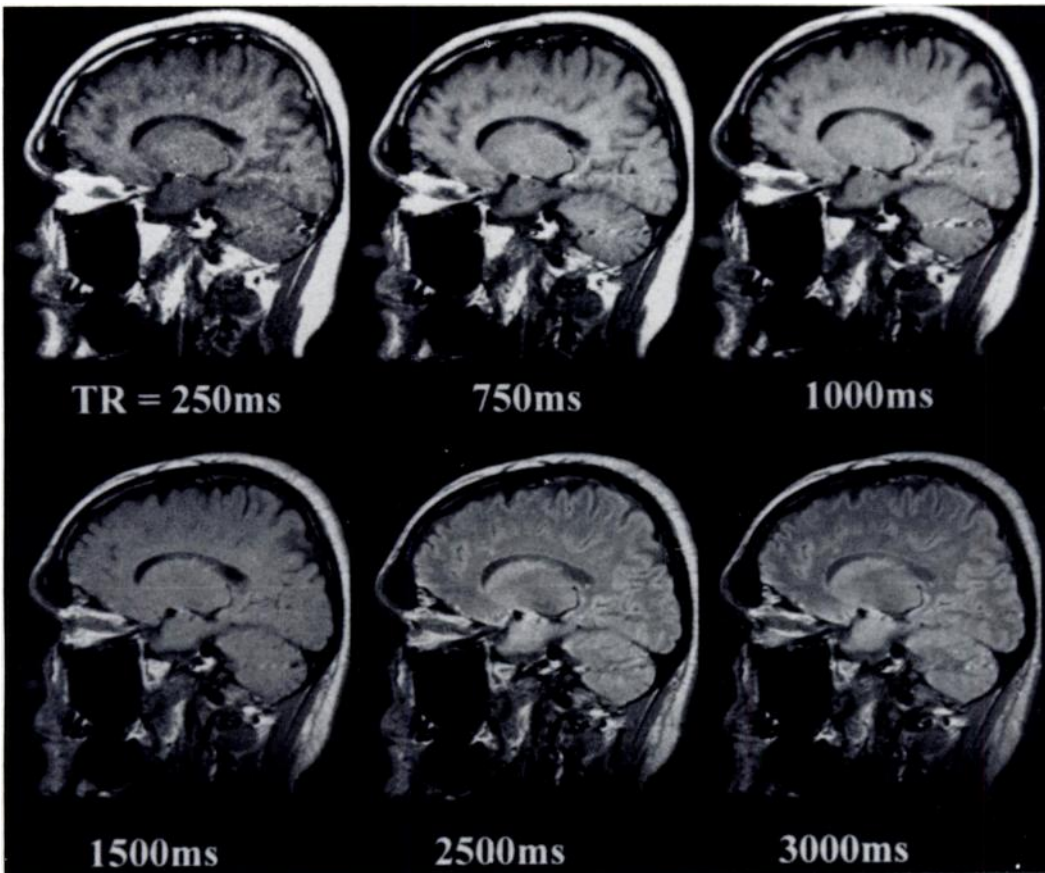

Figure 8. Sagittal images of the head obtained at various TR times for a minimum TE (17 msec) demonstrate the effects of T1 and proton density weighting.

typically up to 30–40 sections to be acquired in one scanning sequence, depending on the pulse sequence timing parameters.

● **Contrast in Spin-Echo Imaging**

The choice of pulse sequence timing parameters determines the contrast in spin-echo images. The TR value controls the amount of T1 weighting, and the TE value controls the amount of T2 weighting.

The effect of TR on image contrast is seen in Figure 7, which demonstrates the maximum detectable signal from gray and white matter. As TR increases, magnetization is allowed to return more fully to its maximum value. At long TR intervals, the difference in signal intensity arising from T1 relaxation vanishes and contrast arises solely from the differences in proton density between the two tissues. At shorter TR intervals (on the order of tissue T1 values), gray matter magnetization recovers more slowly than does white matter magnetization because of the

longer T1 relaxation time of gray matter. However, because the proton density of gray matter is greater than that of white matter, the two recoveries cross at approximately 1,300 msec (Fig 7). On spin-echo images obtained with TRs longer than 1,300 msec, the signal from gray matter dominates (Fig 8). In addition, signal-to-noise ratio increases with increased TR due to a more complete return to maximum magnetization.

As seen in Figure 8, the contrast between gray and white matter is well resolved at short (similar to T1 values) and long (2,500 msec) TR intervals, which correspond to T1-weighted and proton density-weighted sequences, respectively. At intermediate TR intervals (1,500 msec), the contrast between the two tissues vanishes, as indicated in Figure 7.

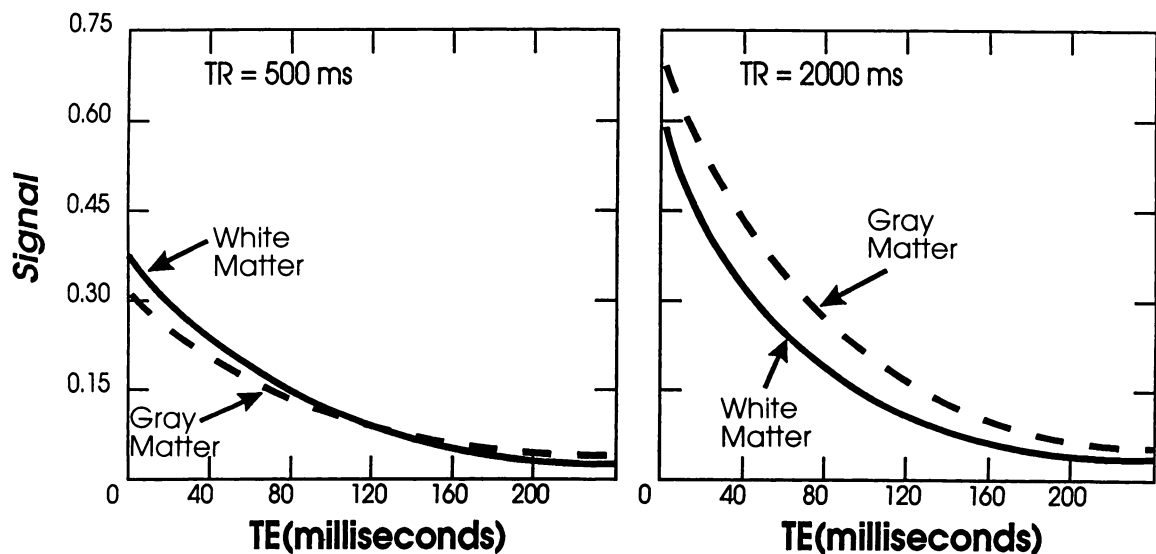

Figure 9. Plots demonstrate the effect of varying TE in a spin-echo image with a short TR (500 msec) interval (left) and a long TR (2,000 msec) interval (right) for gray and white matter.

The effect of variable TE on signal is seen in Figure 9. For a pulse sequence with a TR of 500 msec, the signal from white matter is greater than that of gray matter for TEs less than 60 msec (Fig 9a). For larger TE values, gray matter dominates, whereas intermediate values of TE cause the contrast between gray and white matter to vanish. For a pulse sequence with a TR of 2,000 msec, the signal from gray matter is consistently greater than that of white matter over a wide range of TE values (Fig 9b). As seen in Figure 10, images formed with short TR intervals and long TE values exhibit very low signal-to-noise ratio and negligible contrast and should be avoided.

It is clear that three distinct regions of contrast occur (Fig 11). Images acquired with a minimum TE value and a TR value approximately equal to the T1 of the tissue are predominantly T1 weighted. Similarly, images acquired with a long TR value and a TE value approximately equal to the tissue T2 value are T2 weighted. It is important to note that proton density weighting is always present in spin-echo images. Although in principle the contributions from T1 and T2 can be minimized by using a pulse sequence with minimum TE and long TR values to reduce the influence of all relaxation effects, in practice the minimum TE

limits of MR imaging systems result in some T2 weighting for tissues with very short T2 values, such as tendons.

■ FAST SPIN-ECHO IMAGING

The acquisition times for T1- and T2-weighted spin-echo imaging can range from 1 to 10 minutes, depending on the choice of TR, the number of pixels in the phase-encoding direction, and the number of signals averaged used in data acquisition. Protracted acquisition times are problematic, since they lead to reduced clinical throughput and increase the potential for motion artifacts. These problems have led to an ongoing search for pulse sequences that provide the clinical image quality of spin-echo sequences but at faster acquisition rates. Although gradient-recalled sequences can be used to produce images in seconds, limitations in terms of image contrast and artifacts arising from variable tissue susceptibility result in images with contrast that is degraded considerably from that typical of spin-echo images.

One approach for providing image quality similar to that of conventional spin-echo imaging is through the use of a variant of the rapid acquisition with relaxation enhancement (RARE) sequence (12-14), which is referred to as fast spin-echo or turbo spin-echo imaging by various manufacturers. To understand the operation of this sequence, it is necessary to appreciate how the data are acquired and organized in conventional MR imaging.

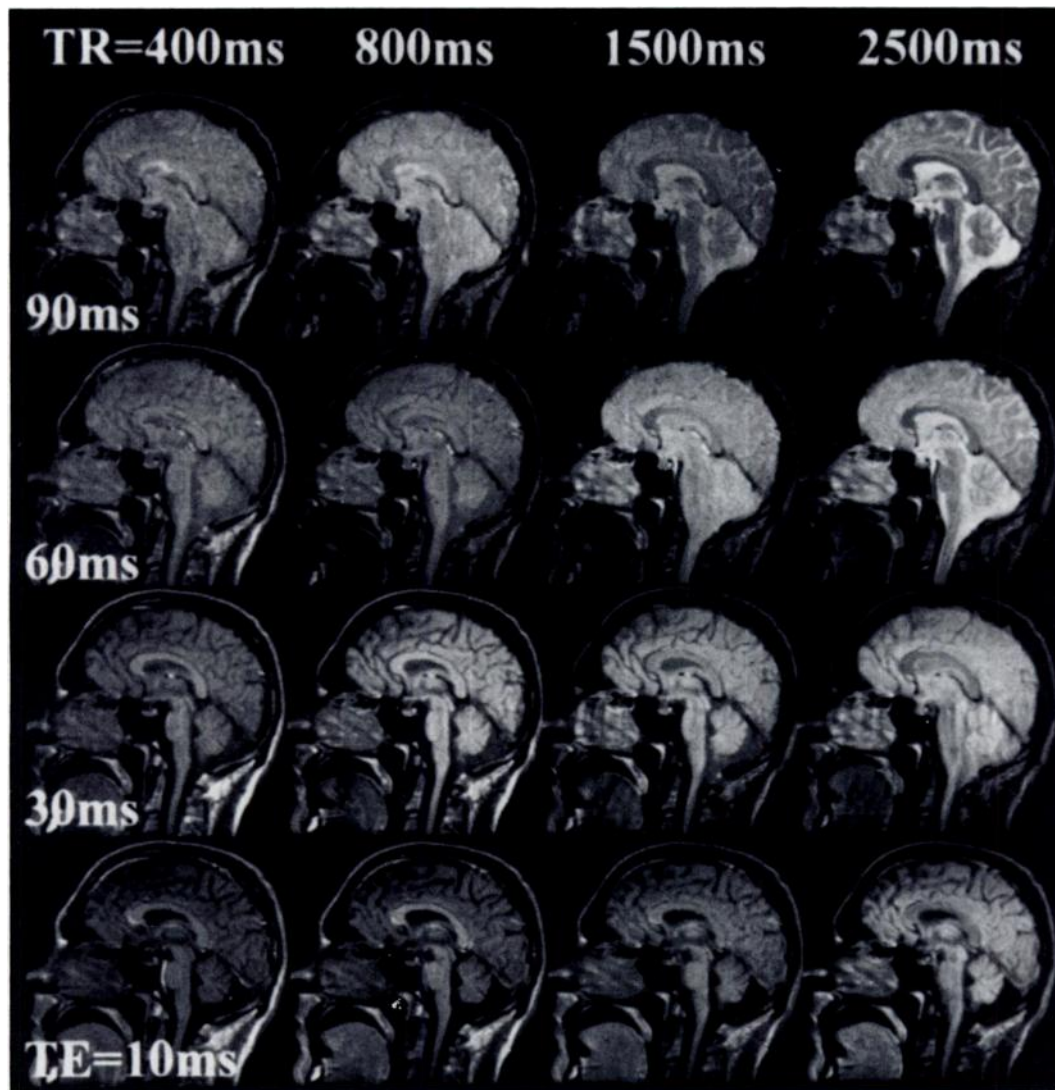

Figure 10. Sagittal images of the head obtained with TR intervals of 400–2,500 msec and TE values of 10–90 msec demonstrate the effects of short TR and long TE values.

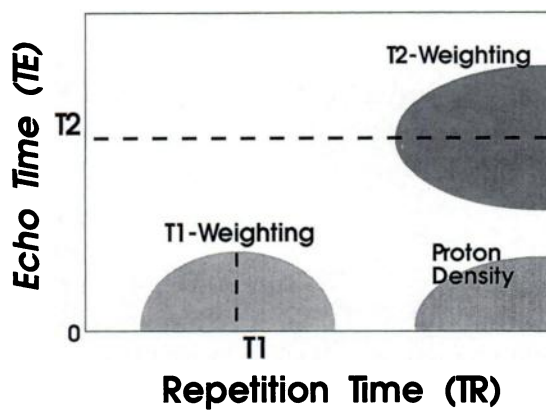

Figure 11. Diagram depicts various types of contrast for spin-echo imaging. The hatched regions correspond to the TR and TE combinations needed for proton density, T1, and T2 weighting.

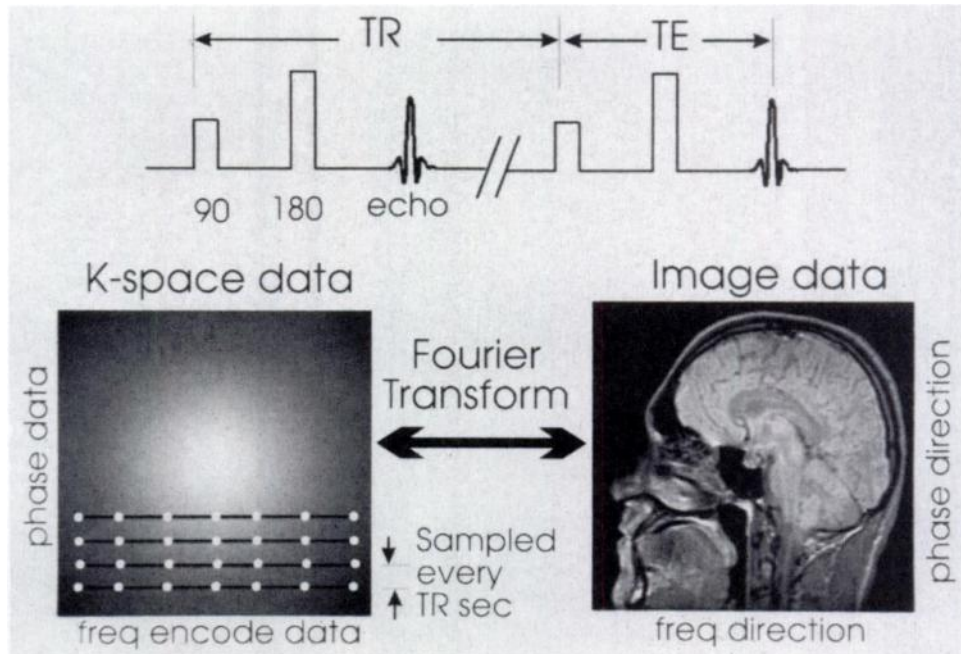

Figure 12. Images demonstrate a simplified spin-echo sequence (top), together with the raw data (lower left) and the reconstructed image (lower right). Raw acquisition data are stored in k space in a line by line fashion. This is repeated on an interval of TR seconds until all of k space is filled. Reconstruction of the data with a Fourier transform produces the final image. *freq* = frequency.

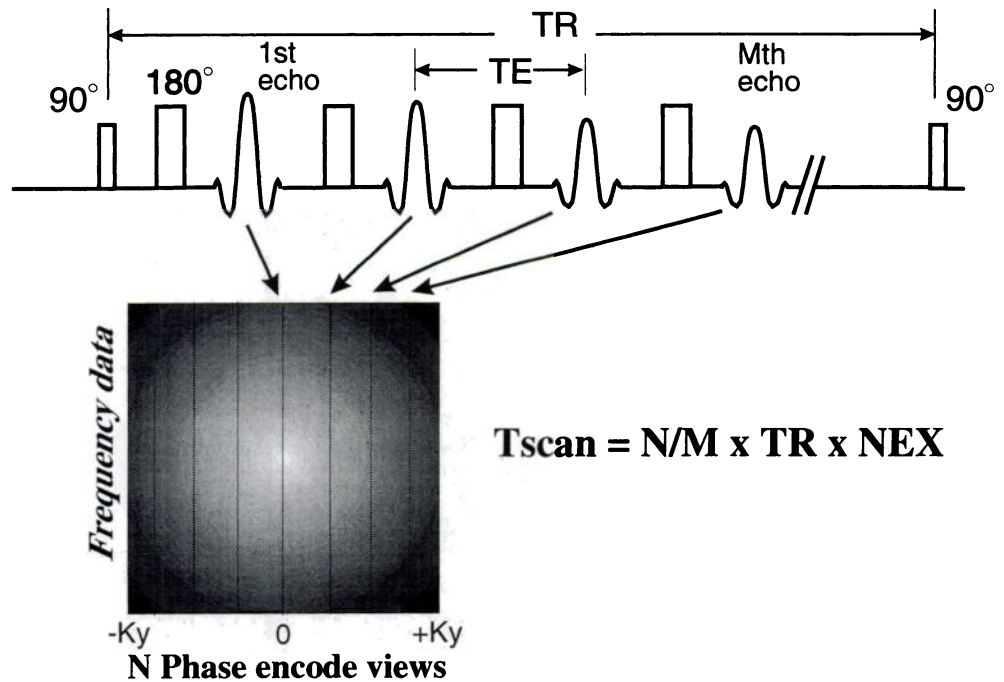

Figure 13. Diagram demonstrates a fast spin-echo sequence. M phase-encoding views are obtained from a single 90° pulse and are distributed evenly over k space. This reduces the number of repetitions needed to fill k space and the total scan time (T_{scan}) by a factor of M . $-Ky$ and $+Ky$ = the range of phase-encoding views required, NEX = number of averages.

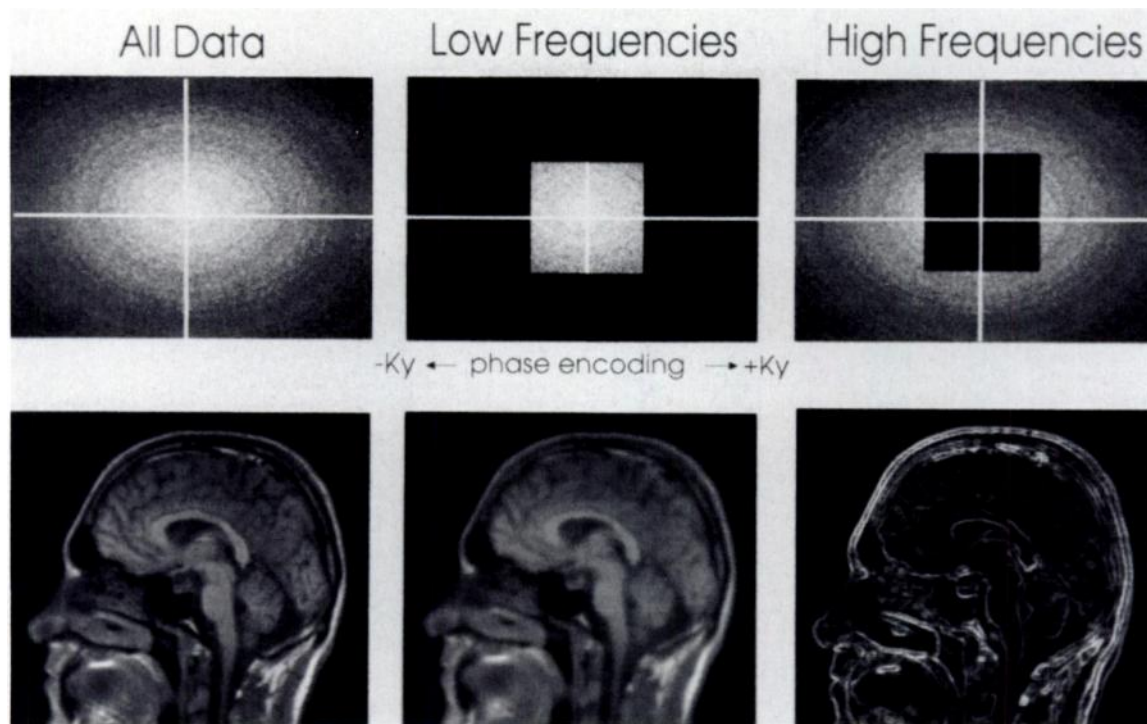

Figure 14. Images illustrate how the various regions of k space (upper row) can be reconstructed, with the corresponding images (bottom row). Reconstructions are shown for all of the data (left), the center of k space (center), and the outer regions of k space (right).

Figure 12 shows an abbreviated depiction of the conventional spin-echo sequence, together with the raw data and the reconstructed image. As mentioned, each spin echo is typically sampled 256 times throughout its duration. The resultant "line" of raw data is recorded as a "view" in the raw data domain or "k space." K space is then sequentially filled line by line until all of the necessary phase-encoding views have been completed. The final image is formed through a reconstruction of the k-space data by means of Fourier transformation. Thus, for each phase-encoded view, an 90° - 180° excitation sequence is required, which in turn requires an interval of TR seconds. In the fast spin-echo sequence, several k-space views are collected for each 90° excitation pulse by using multiple 180° pulses to form a number of separately phase-encoded spin echoes during a single TR interval (Fig 13). Thus, if M views are collected during each TR interval, the final acquisition time would be reduced by this factor.

This approach appears to contradict the earlier description of how contrast in spin-echo images is formed, since the fast spin-echo sequence uses multiple echoes, each with a different T2 weighting. Accordingly, one would expect this mixing of echoes in k space to lead to a very complex image contrast. The apparent difficulty, however, can be easily resolved. As

seen in Figure 14, if all of the data in k space are used for image reconstruction, the image has full detail and contrast. If only data from a portion of the center of k space are used, the reconstructed image looks much the same, with a clear rendering of overall image contrast and shape but without edge definition. Conversely, if only data from the outer regions of k space are used, the image lacks the broad area contrast but has edge detail.

Thus, data acquired near the center of k space render the overall image contrast, whereas data collected at the outer regions encode the edge detail. This suggests that image contrast in fast spin-echo imaging can be adjusted by choosing which echo will be encoded near the center of k space to ensure proper contrast and by using the remaining echoes to collect edge detail. In a T1-weighted fast spin-echo sequence, the earliest echoes, which are the ones that are most T1 weighted, are chosen to sample the central region of k space, and later echoes are progressively spaced toward the outer regions of k space (Fig 15). Conversely, a heavily T2-weighted sequence, which corresponds to the TE of the last echo, reverses the echo and phase-encoding order, with the last echo used to en-

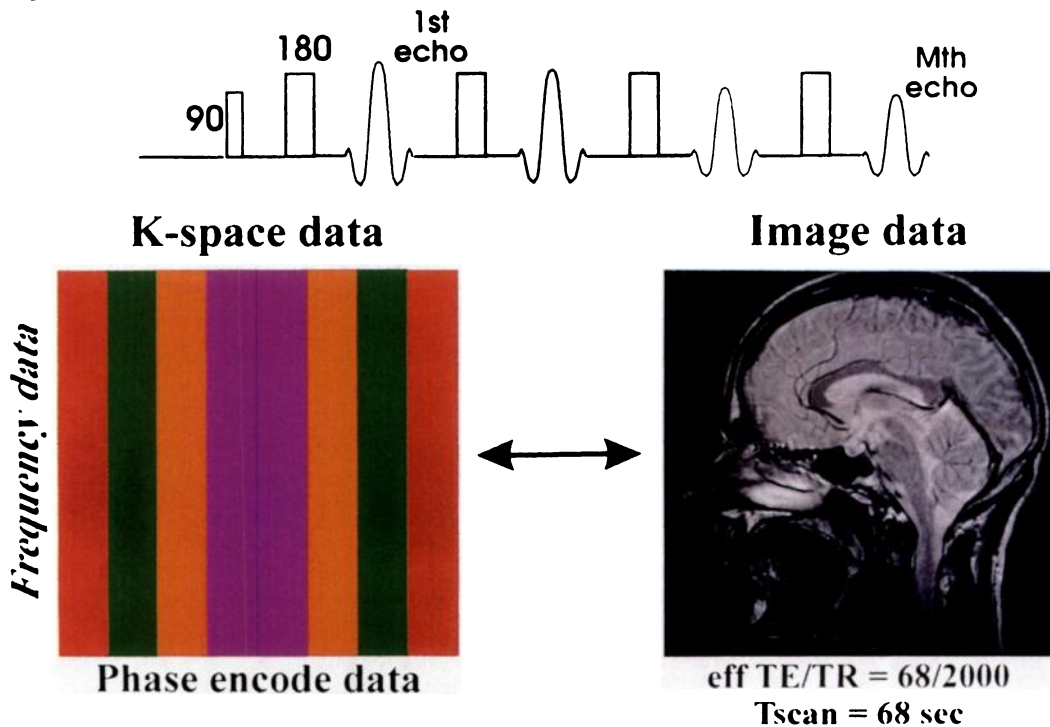
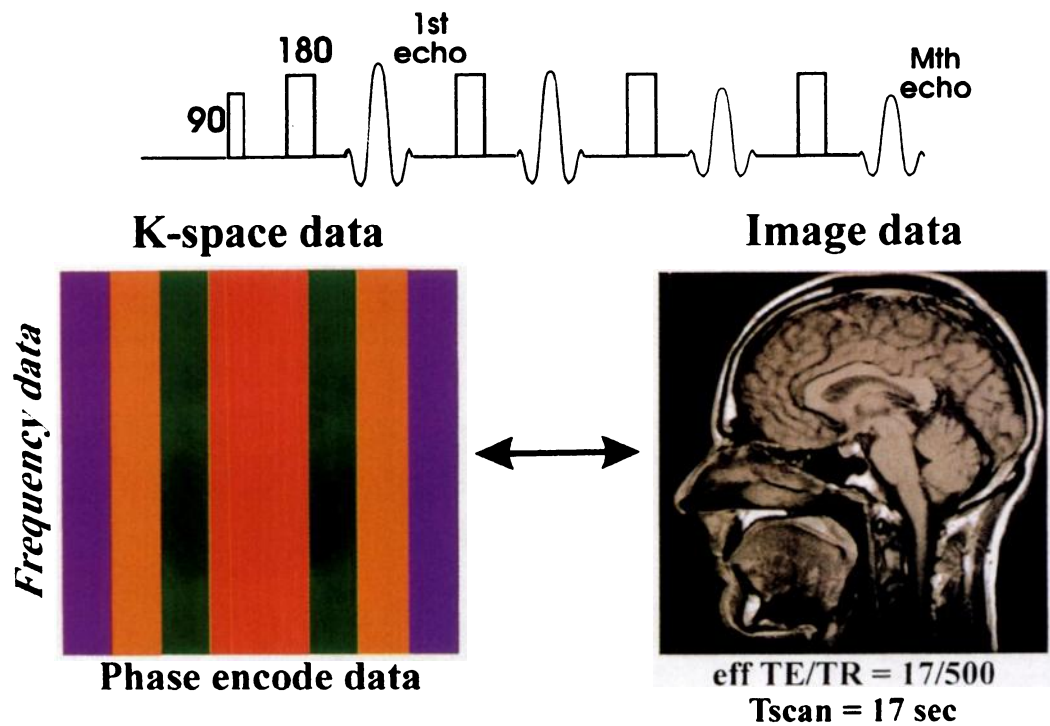

Figures 15, 16. Placement of the multiple echoes of a fast spin-echo sequence (top) and into their corresponding locations in k space (bottom). **(15)** A T1-weighted sequence places the earliest echo in the center of k space, with later echoes used to encode the rest of k space as shown. In this case, the TR interval is chosen to provide T1 weighting to the image. **(16)** A T2-weighted sequence places the last echo in the center of k space, with earlier echoes used to encode the rest of k space as shown. The effective TE corresponds to that of the fourth echo.

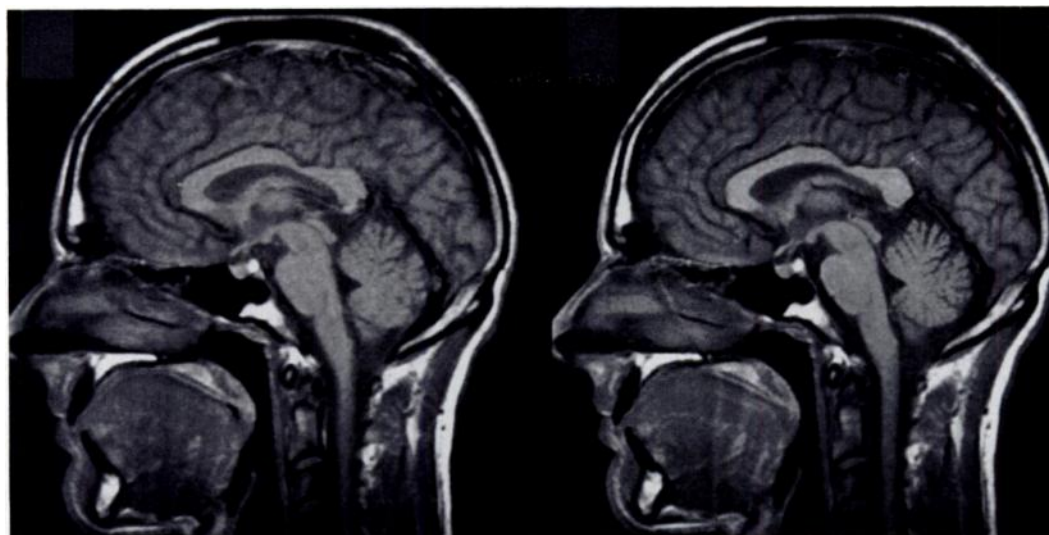

17.

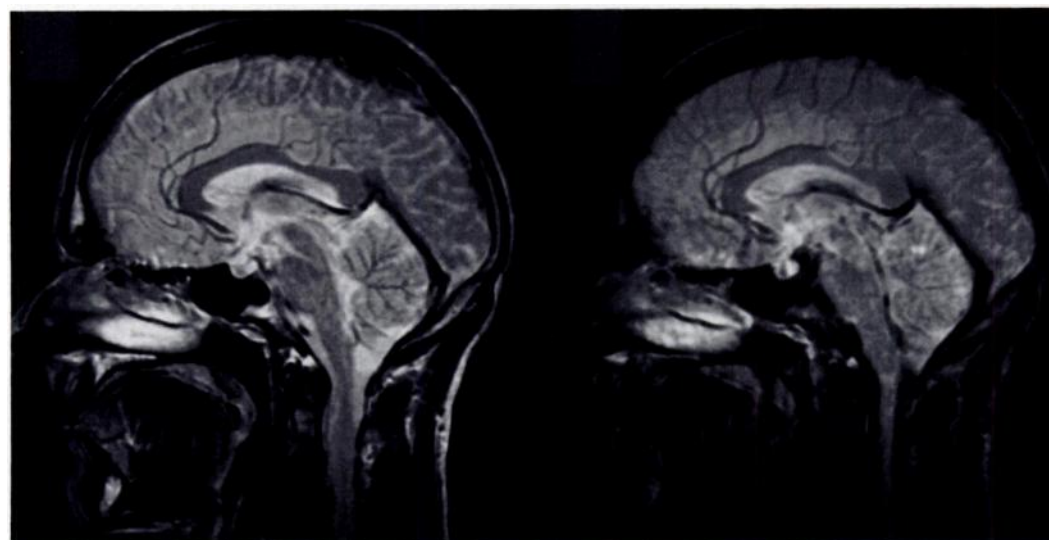

18.

Figures 17, 18. (17) T1-weighted images obtained with a conventional spin-echo sequence (right) and a fast spin-echo sequence (left) with an echo train length of four and a 500-msec TR. The images are very similar, even though the fast spin-echo image was obtained four times faster. The latter image shows a slight reduction in resolution due to echo decay throughout the echo train. (18) T2-weighted images obtained with a conventional spin-echo sequence (right) and a fast spin-echo sequence (left) with an echo train length of four and a 2,000-msec TR. TE was 68 msec for the conventional image, and the TE encoding the center of k space in the fast spin-echo image was also 68 msec. The images are very similar, even though the fast spin-echo image was obtained four times faster. Blurring seen in the T1-weighted fast spin-echo image is not apparent in the T2-weighted fast spin-echo image because the earlier echoes are used to sample the higher frequency phase-encoding views.

code the central region of k space and earlier echoes progressively spaced toward the outer regions of k space (Fig 16). If an intermediate echo were chosen for a T2-weighted sequence, an intermediate ordering of echoes would be placed at the center of k space, with the remaining echoes used to acquire the remaining regions of k space.

In all cases, the TE corresponding to the echo that encodes the central region of k space is the TE responsible for the overall image con-

trast. This is shown in Figures 17 and 18, which compare the fast spin-echo and conventional spin-echo sequences for both T1- and T2-weighted images of the head. The fast spin-echo images, which were obtained with shorter acquisition times, are virtually identical to the conventional spin-echo images. Fast spin-echo sequences that use a long echo train with more

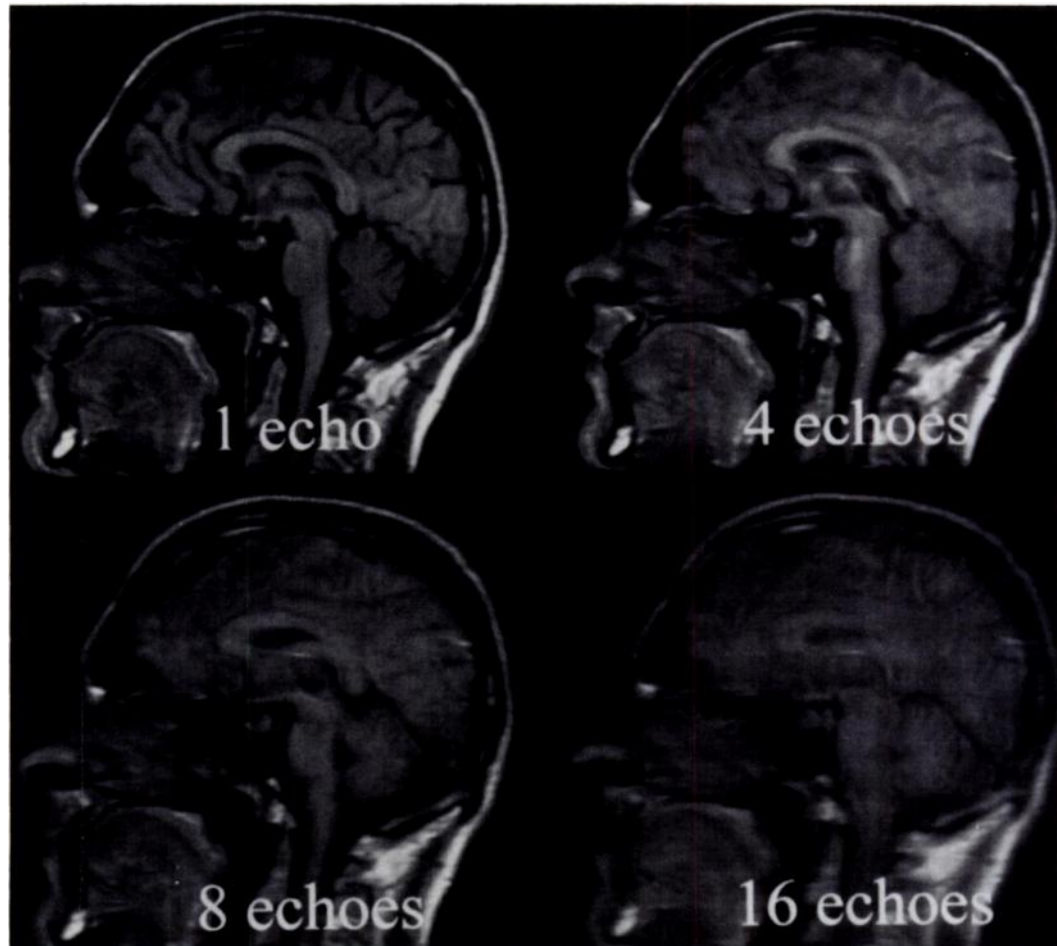

Figure 19. T1-weighted fast spin-echo images obtained with decreasing acquisition times by using echo train lengths of one (upper left), four (upper right), eight (lower left), and 16 (lower right). The acquisition time, relative to that needed for a conventional spin-echo image, is reduced in proportion to the echo train length used in the fast spin-echo sequence. As the echo train length increases, the resolution in the phase-encoding direction degrades due to T2 decay.

echoes can progressively increase scanning speed but at the cost of some image degradation, which is characteristic of the fast spin-echo sequence.

● **Artifacts and Limitations in Fast Spin-Echo Imaging**

The use of multiple refocusing pulses to collect several phase-encoding views introduces a number of subtle artifacts in fast spin-echo images, the full description of which is beyond the scope of this article. The most notable artifact is a T2-dependent resolution in T1-weighted images. The mechanism for this effect can be un-

derstood if we consider the pulse sequence shown in Figure 15. The use of multiple echoes to encode various regions of k space is influenced by the decay of the echo train from T2 relaxation. Specifically, as the later echoes are used to encode the outer regions of k space, signal decay for these echoes will attenuate the data that correspond to edge detail in the image. Thus, the shorter the T2 value for a given tissue, the greater the attenuation of edge detail for that tissue. Conversely, the more the speed of the fast spin-echo sequence is increased by using more echoes, the greater will be the T2 decay of edge detail throughout the image, with the greatest resolution loss occurring for those tissues with shortest T2. As seen in Fig-

ure 19, when a fast spin-echo sequence is performed with a single echo, the resultant image is identical to a conventional spin-echo image, with uniform resolution. As a greater number of echoes are used to increase scanning speed, a clear loss of resolution in the phase-encoding direction is seen. Thus, in fast spin-echo imaging, a compromise must be made between scanning speed and resolution. The choice must be based on consideration of the T2 values of the tissues involved in the image and the interecho delay time used in the sequence. The inverse of this situation can occur in T2-weighted sequences, in which earlier echoes are used to encode the outer regions of k space. This results in a subtle apparent increase in image resolution throughout the image due to an increase in the magnitude of echoes at the outer regions of k space relative to that seen on conventional spin-echo images (Fig 18). In general, this effect is modest and usually not troublesome.

Because of the long echo train typical of fast spin-echo sequences, the number of sections that can be interleaved for a given TR interval will be reduced. For example, in a conventional T1-weighted sequence (700/20 [TR msec/TE msec]), approximately 35 sections can be acquired. In a fast spin-echo sequence with an echo train length of eight and the same TR interval, the echo train will last approximately 160 msec and only four sections can be acquired, since the time taken to collect multiple k-space views is not available to interleave sections. The reduced number of sections is a fundamental limitation of T1-weighted fast spin-echo sequences, since the TR interval is carefully chosen to maximize image contrast. It is feasible to increase the TR value somewhat because the echo train can be quite long; however, limitations in section number still remain. In the T2-weighted fast spin-echo sequence, this issue is not as problematic because the TR interval can easily be increased to accommodate more sections. T2-weighted sequences have the added benefit of improving signal-to-noise ratio and net contrast. Although increasing TR partially reduces the speed advantages of fast spin-echo methods, the gains in speed in the clinical setting are still significant in selected applications.

■ CONCLUSIONS

Spin-echo imaging and its derivatives remain the most common form of clinical MR imaging performed today. The capability of providing images of high signal-to-noise ratio and contrast that are robust in terms of artifact formation is among the strengths of this pulse sequence. The exquisite T2 contrast that can be delivered by spin-echo methods remains a standard of clinical imaging, against which alternative sequences must be compared. Nevertheless, the overall acquisition times for spin-echo sequences can be long. More recently, fast spin-echo sequences have been introduced, and they are generally found to provide very competitive contrast and signal-to-noise ratio at acquisition times that can be up to eightfold shorter.

■ REFERENCES

1. Hahn EL. Spin echoes. *Phys Rev* 1950; 80: 580-594.
2. Bloch F. Nuclear induction. *Phys Rev* 1946; 70:460-474.
3. Purcell EM, Torrey HC, Pound RV. Resonance absorption by nuclear magnetic moments in a solid. *Phys Rev* 1946; 69:37-38.
4. Carr H, Purcell EM. Effects of diffusion on free precession in nuclear magnetic resonance experiments. *Phys Rev* 1954; 94:630-638.
5. Meiboom S, Gill D. Modified spin-echo method for measuring nuclear relaxation times. *Rev Sci Instr* 1958; 29:688-691.
6. Hendrick RE, Ulrick R. Image contrast and noise. In: Stark DD, Bradley WG, eds. *Magnetic resonance imaging*. Chicago, Ill: Mosby-Year Book, 1992; 109-144.
7. Bottomley PA, Foster TH, Argersinger RD, et al. A review of normal tissue hydrogen NMR relaxation times and relaxation mechanisms from 1-100 Mhz: dependence on tissue type, NMR frequency, temperature, excision, and age. *Med Phys* 1984; 11:425-448.
8. Plewes DB, Bishop J. Spin echo MR imaging. In: Bronskill MJ, Sprawls P, eds. *The physics of MRI*. Medical Physics Monograph no. 21. New York, NY: American Association of Physicists in Medicine, 1992; 167-187.

9. Gomori JM, Grossman RI. Mechanisms responsible for the MR appearance and evolution of intracranial hemorrhage. *RadioGraphics* 1988; 8:427-440.
10. Grossman RI, Gomori JM, Goldberg HI, et al. MR imaging of hemorrhagic conditions of the head and neck. *RadioGraphics* 1988; 8:441-454.
11. Crooks L, Arakawa M, Hoenninger J, et al. Nuclear magnetic resonance whole-body imager operating at 3.5 KGauss. *Radiology* 1982; 143:169-174.
12. Hennig J, Naureth A, Friedburg H. RARE imaging: a fast imaging method for clinical MR. *Magn Reson Med* 1986; 3:823-833.
13. Melki PS, Mulkern RV, Panych LP, Jolesz FA. Comparing the FAISE method with conventional dual-echo sequences. *JMRI* 1991; 1:319-326.
14. Mulkern RV, Wong STS, Winalski C, et al. Contrast manipulation and artifact assessment in 2D and 3D RARE sequences. *Magn Reson Imaging* 1990; 8:557-566.

Answers for September 1994 CME Test 2

The answers for the test on *MR Imaging Instrumentation and Image Artifacts*, published in the September issue of *RadioGraphics* (RadioGraphics 1994; 14:1083-1096), are given below.

1. d 2. a 3. b 4. c 5. b 6. d 7. b 8. c 9. d 10. c

Erratum

“CT Evaluation of the Anterior Mediastinum: Spectrum of Disease.”
RadioGraphics 1994; 14:973-990.

Page 976, column 2, line 2: The sentence beginning “The attenuation...” should read as follows: “The attenuation before administration of contrast material is usually in the range of 46-75 HU, similar to that of the chest wall musculature (10); cystic-appearing thymomas of low attenuation have also been identified.”

Page 981, column 1, second paragraph: The following article was used in the preparation of this paragraph and should have been cited here and included in the reference list: Hopper K, Diehl L, Cole B, Lynch J, Meilstrup J, McCauslin M. The significance of necrotic mediastinal lymph nodes on CT in patients with newly diagnosed Hodgkin disease. *AJR* 1990; 155:267-270.