

Chapter 6

Particle Spin and the Stern-Gerlach Experiment

THE spin of an elementary particle would appear, on the surface, to be little different from the spin of a macroscopic object – the image of a microscopic sphere spinning around some axis comes to mind. However, there is far more going on here than what this simple picture might suggest. But first, a brief look at what the classical properties are of angular momentum is needed.

6.1 Classical Spin Angular Momentum

A particle moving through space possesses angular momentum, a vector, defined by

$$\mathbf{L} = \mathbf{r} \times \mathbf{p} \quad (6.1)$$

where \mathbf{r} and \mathbf{p} are the position vector and momentum respectively of the particle. This is sometimes referred to as *orbital* angular momentum since, in particular, it is an important consideration in describing the properties of a particle orbiting around some centre of attraction such as, in the classical picture of an atom, electrons orbiting around an atomic nucleus. Classically there is no restriction on the magnitude or direction of orbital angular momentum.

From a classical perspective, as an electron carries a charge, its orbital motion will result in a tiny current loop which will produce a dipolar magnetic field. The strength of this dipole field is measured by the magnetic moment $\boldsymbol{\mu}$ which is related to the orbital angular momentum by

$$\boldsymbol{\mu}_L = \frac{q}{2m} \mathbf{L}. \quad (6.2)$$

Thus, the expectation on the basis of this classical picture is that atoms can behave as tiny little magnets.

The classical idea of spin follows directly from the above considerations. Spin is the angular momentum we associate with a rotating object such as a spinning golf ball, or the spinning Earth. The angular momentum of such a body can be calculated by integrating over the contributions to the angular momentum due to the motion of each of the infinitesimal masses making up the body. The well known result is that the total angular momentum or spin \mathbf{S} is given by

$$\mathbf{S} = I\boldsymbol{\omega} \quad (6.3)$$

where I is the moment of inertia of the body, and $\boldsymbol{\omega}$ is its angular velocity. Spin is a vector which points along the axis of rotation in a direction determined by the right hand rule: curl the fingers of the right hand in the direction of rotation and the thumb points in the direction of \mathbf{S} . The moment of inertia is determined by the distribution of mass in the rotating body relative to the axis of rotation. If the object were a solid uniform sphere of mass m and radius a , and rotation were about a diameter of the sphere, then the moment of inertia can be shown to be

$$I = \frac{2}{5}Ma^2. \quad (6.4)$$

If the sphere possesses an electric charge, then the circulation of the charge around the axis of rotation will constitute a current and hence will give rise to a magnetic field. This field is a dipole field whose strength is measured by the dipole moment which can be shown, for a uniformly charged sphere of total charge q , to be given by

$$\boldsymbol{\mu}_s = \frac{q}{2m} \mathbf{S}, \quad (6.5)$$

exactly the same as in the orbital case.

The point to be made here is that the spinning object is extended in space, i.e. the spinning sphere example has a non-zero radius. If we try to extend the idea to a *point* particle by taking the limit of $a \rightarrow 0$ we immediately see that the spin angular momentum must vanish unless ω is allowed to be infinitely large. If we exclude this last possibility, then classically a point particle can only have a spin angular momentum of zero and so it cannot have a magnetic moment. Thus, from the point-of-view of classical physics, elementary particles such as an electron, which are known to possess spin angular momentum, cannot be viewed as point objects – they must be considered as tiny spinning spheres. But as far as it has been possible to determine by high energy scattering experiments, elementary particles such as the electron behave very much as point particles. Whatever radius they might have, it is certainly very tiny: experiment suggests it is $< 10^{-17}$ m. Yet they are found to possess spin angular momentum of a magnitude equal (for the electron) to $\sqrt{3}/\hbar/2$ which requires the surface of the particle to be moving at a speed greater than that of light. This conflict with special relativity makes this classical picture of an elementary particle as a tiny, rapidly rotating sphere obviously untenable. The resolution of this problem can be found within quantum mechanics, though this requires considering the relativistic version of quantum mechanics: the spin of a point particle is identified as a relativistic effect. We shall be making use of what quantum mechanics tells us about particle spin, though we will not be looking at its relativistic underpinnings. On thing we do learn, however, is that spin is not describable in terms of the wave function idea that we have been working with up till now.

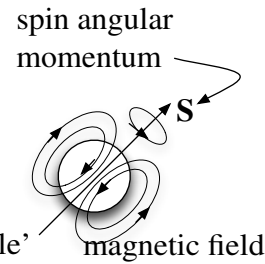

Figure 6.1: Magnetic field produced by a spinning charged sphere.

6.2 Quantum Spin Angular Momentum

Wave mechanics and the wave function describe the properties of a particle moving through space, giving, as we have seen, information on its position, momentum, energy. In addition it also provides, via the quantum mechanical version of $\mathbf{L} = \mathbf{r} \times \mathbf{p}$ a quantum description of the *orbital* angular momentum of a particle, such as that associated with an electron moving in an orbit around an atomic nucleus. The general results found are that the magnitude of the angular momentum is limited to the values

$$L = \sqrt{l(l+1)}\hbar, \quad l = 0, 1, 2, 3, \dots, \quad (6.6)$$

which can be looked on as an ‘improved’ version of the result used by Bohr, the one subsequently ‘justified’ by the de Broglie hypothesis, that is $L = n\hbar$, Eq. (2.5). The quantum theory of orbital angular momentum also tells us that any one vector component of \mathbf{L} , L_z say, is restricted to the values

$$L_z = m_l \hbar, \quad m_l = -l, -l+1, -l+2, \dots, l-2, l-1, l. \quad (6.7)$$

This restriction on the possible values of L_z mean that the angular momentum vector can have only certain orientations in space – a result known as ‘space quantization’.

All this is built around the quantum mechanical version of $\mathbf{L} = \mathbf{r} \times \mathbf{p}$, and so implicitly is concerned with the angular momentum of a particle moving through space. But a more general perspective yields some surprises. If special relativity and quantum mechanics are combined, it is found that

even if a particle, a point object, has zero momentum, so that the orbital angular momentum is zero, its total angular momentum is, in general, *not zero*. The only interpretation that can be offered is that this angular momentum is due to the intrinsic spin of the particle. The possible values for the magnitude S of the spin angular momentum turn out to be

$$S = \sqrt{s(s+1)}\hbar, \quad s = 0, \frac{1}{2}, 1, \frac{3}{2}, 2, \dots \quad (6.8)$$

and any one vector component of \mathbf{S} , S_z say, is restricted to the values

$$S_z = m_s \hbar, \quad m_s = -s, -s+1, -s+2, \dots, s-2, s-1, s \quad (6.9)$$

i.e. similar to orbital angular momentum, but with the significant difference of the appearance of half integer values for the spin quantum number s in addition to the integer values. This theoretical result is confirmed by experiment. In nature there exist elementary particles for which $s = \frac{1}{2}, \frac{3}{2}, \frac{5}{2}, \dots$ such as the electron, proton, neutron, quark (all of which have spin $s = \frac{1}{2}$), and more exotic particles of higher half-integer spin, while there exist many particles with integer spin, the photon, for which $s = 1$, being the most well-known example, though because it is a zero rest mass particle, it turns out that S_z can only have the values ± 1 . Of particular interest here is the case of $s = \frac{1}{2}$ for which there are two possible values for S_z , that is $S_z = \pm \frac{1}{2}\hbar$.

Particle spin is what is left after the contribution to the angular momentum due to motion through space has been removed. It is angular momentum associated with the internal degrees of freedom of a point particle, whatever they may be, and cannot be described mathematically in terms of a wave function. It also has no classical analogue: we have already seen that a point particle cannot have spin angular momentum. Thus, particle spin is a truly quantum property that cannot be described in the language of wave functions – a more general mathematical language is required. It was in fact the discovery of particle spin, in particular the spin of the electron, that led to the development of a more general version of quantum mechanics than that implied by wave mechanics.

There is one classical property of angular momentum that does carry over to quantum mechanics. If the particle is charged, and if it possesses either orbital or spin angular momentum, then there arises a dipole magnetic field. In the case of the electron, the dipole moment is found to be given by

$$\boldsymbol{\mu}_s = -\frac{e}{2m_e} g \mathbf{S} \quad (6.10)$$

where m_e and $-e$ are the mass and charge of the electron, \mathbf{S} is the spin angular momentum of the electron, and g is the so-called gyromagnetic ratio, which classically is exactly equal to one, but is known (both from measurement and as derived from relativistic quantum mechanics) to be approximately equal to two for an electron. It is the fact that electrons possess a magnetic moment that has made it possible to perform experiments involving the spin of electrons, in a way that reveals the intrinsically quantum properties of spin.

6.3 The Stern-Gerlach Experiment

This experiment, first performed in 1922, has long been considered as the quintessential experiment that illustrates the fact that the electron possesses intrinsic angular momentum, i.e. spin. It is actually the case that the original experiment had nothing to do with the discovery that the electron possessed spin: the first proposal concerning the spin of the electron, made in 1925 by Uhlenbach and Goudsmit, was based on the analysis of atomic spectra. What the experiment was intended to test was ‘space-quantization’ associated with the orbital angular momentum of atomic electrons. The prediction, already made by the ‘old’ quantum theory that developed out of Bohr’s work, was that the spatial components of angular momentum could only take discrete values, so

that the direction of the angular momentum vector was restricted to only a limited number of possibilities, and this could be tested by making use of the fact that an orbiting electron will give rise to a magnetic moment proportional to the orbital angular momentum of the electron. So, by measuring the magnetic moment of an atom, it should be possible to determine whether or not space quantization existed. In fact, the results of the experiment were in agreement with the then existing (incorrect) quantum theory – the existence of electron spin was not at that time suspected. Later, it was realized that the interpretation of the results of the experiment were incorrect, and that what was seen in the experiment was direct evidence that electrons possess spin. It is in this way that the Stern-Gerlach experiment has subsequently been used, i.e. to illustrate the fact that electrons have spin. But it is also valuable in another way. The simplicity of the results of the experiment (only two possible outcomes), and the fact that the experiment produces results that are directly evidence of the laws of quantum mechanics in action makes it an ideal means by which the essential features of quantum mechanics can be seen and, perhaps, ‘understood’.

The original experimental arrangement took the form of a collimated beam of silver atoms heading in, say, the y direction, and passing through a non-uniform magnetic field directed (mostly) in the z -direction. Assuming the silver atoms possess a non-zero magnetic moment $\boldsymbol{\mu}$, the magnetic field will have two effects. First, the magnetic field will exert a torque on the magnetic dipole, so that the magnetic moment vector will *precess* about the direction of the magnetic field. This will not affect the z component of $\boldsymbol{\mu}$, but the x and y components of $\boldsymbol{\mu}$ will change with time. Secondly, and more importantly here, the non-uniformity of the field means that the atoms experience a sideways force given by

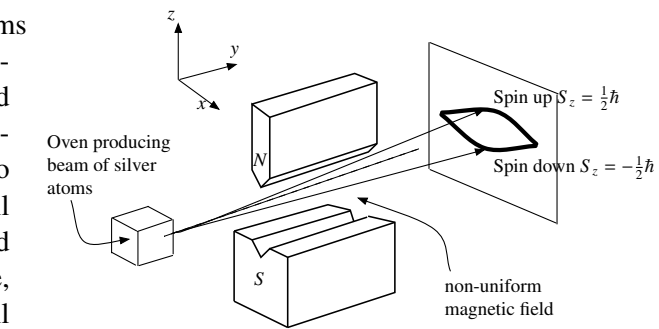

Figure 6.2: The Stern-Gerlach apparatus.

where $U = -\boldsymbol{\mu} \cdot \mathbf{B} = -\mu_z B$ is the potential energy of the silver atom in the magnetic field. Thus

$$F_z = -\frac{\partial U}{\partial z} \quad (6.11)$$

where $U = -\boldsymbol{\mu} \cdot \mathbf{B} = -\mu_z B$ is the potential energy of the silver atom in the magnetic field. Thus

$$F_z = \mu_z \frac{\partial B}{\partial z}. \quad (6.12)$$

Different orientations of the magnetic moment vector $\boldsymbol{\mu}$ will lead to different values of μ_z , which in turn will mean that there will be forces acting on the atoms which will differ depending on the value of μ_z .

The expectation based on classical physics is that due to random thermal effects in the oven, the magnetic dipole moment vectors of the atoms will be randomly oriented in space, so there should be a continuous spread in the z component of the magnetic moments of the silver atoms as they emerge from the oven, ranging from $-|\mu_z|$ to $|\mu_z|$. A line should then appear on the observation screen along the z direction. Instead, what was found was that the silver atoms arrived on the screen at only two points that corresponded to magnetic moments of

$$\mu_z = \pm\mu_B; \quad \mu_B = \frac{e\hbar}{2m_e} \quad (6.13)$$

where μ_B is known as the Bohr magneton.

Space quantization was clearly confirmed by this experiment, but the full significance of their results was not realized until some time later, after the proposal by Uhlenbach and Goudsmit that the

electron possessed intrinsic spin, and a magnetic moment. The full explanation based on what is now known about the structure of the silver atom is as follows. There are 47 electrons surrounding the silver atom nucleus, of which 46 form a closed inner core of total angular momentum zero – there is no orbital angular momentum, and the electrons with opposite spins pair off, so the total angular momentum is zero, and hence there is no magnetic moment due to the core. The one remaining electron also has zero orbital angular momentum, so the sole source of any magnetic moment is that due to the intrinsic spin of the electron as given by Eq. (6.10).

Thus, the experiment represents a direct measurement of one component of the spin of the electron, this component being determined by the direction of the magnetic field, here taken to be in the z direction.

There are two possible values for S_z , corresponding to the two spots on the observation screen, as required by the fact that $s = \frac{1}{2}$ for electrons, i.e. they are spin- $\frac{1}{2}$ particles. The allowed values for the z component of spin are

$$S_z = \pm \frac{1}{2} \hbar \quad (6.14)$$

which, with the gyromagnetic value of two, yields the two values given in Eq. (6.13) for μ_z .

Of course there is nothing special about the direction z , i.e. there is nothing to distinguish the z direction from any other direction in space. What this means is that *any* component of the spin of an electron will have only two values, i.e.

$$S_x = \pm \frac{1}{2} \hbar, \quad S_y = \pm \frac{1}{2} \hbar \quad (6.15)$$

and indeed, if $\hat{\mathbf{n}}$ is a unit vector specifying some arbitrary direction in space, then

$$\mathbf{S} \cdot \hat{\mathbf{n}} = \pm \frac{1}{2} \hbar. \quad (6.16)$$

Thus, by orienting the magnetic field in a Stern-Gerlach device in some direction $\hat{\mathbf{n}}$ perpendicular to the direction of motion of the atoms in the beam, the atoms will emerge in two possible beams, corresponding to $\mathbf{S} \cdot \hat{\mathbf{n}} = \pm \frac{1}{2} \hbar$. The positive sign is usually referred to as spin up in the $\hat{\mathbf{n}}$ direction, the negative sign as spin down in the $\hat{\mathbf{n}}$ direction. In the examples considered so far, the separation has always been in the z direction, i.e. $\hat{\mathbf{n}} = \hat{\mathbf{k}}$, but it is equally well possible to orient the magnetic field to lie in the x direction, i.e. $\hat{\mathbf{n}} = \hat{\mathbf{i}}$, so that the atomic beam is split into two beams with $S_x = \pm \frac{1}{2} \hbar$. In order to represent these possibilities in a diagram of the Stern-Gerlach device, a label will be included on the diagram to indicate the direction in which the magnetic field is oriented, and hence the component of the spin that is being measured. This is illustrated in the diagram Fig. 6.3.

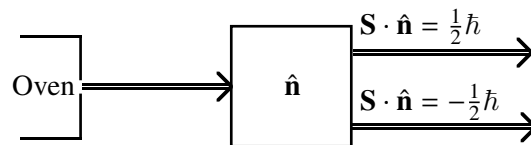

Figure 6.3: Stern-Gerlach device set to separate an atomic beam according to the $\hat{\mathbf{n}}$ component of spin. Separation according to the x component would be represented by the same diagram, except with an X within the rectangle, and similarly for other directions.

We will now use the above stripped-down picture of a Stern-Gerlach device to examine some purely quantum features of particle spin. Although the fact that particle spin is a purely quantum phenomenon, it is not the fact that particle spin exists and is of quantum origin that is of interest here. It is the properties that spin possesses when subject to various measurements that is of importance here – features that all quantum mechanical systems exhibit such as probabilistic outcomes of measurements, interference of probability amplitudes and so on are found to arise, but in circumstances in which there are only a handful of parameters needed to describe what is happening.

6.4 Quantum Properties of Spin

We shall now make use of the Stern-Gerlach apparatus to analyse the quantum properties of spin half in a way analogous to the two slit experiment. In this regard, we will consider repeated spin measurements, quantum randomness for spin and quantum interference for spin.

6.4.1 Spin Preparation and Measurement

sorted out. The first point to recognize is that the Stern-Gerlach apparatus is both a spin preparation device and a spin measurement device. Thus, if an atom should emerge in a beam corresponding to a spin component $S_z = \frac{1}{2}\hbar$, then we can claim that the Stern-Gerlach apparatus has *prepared* the atom to have this specific value for S_z . More than that, we can also claim that the apparatus is a spin measuring device, i.e. if we wish to determine what the z component of the atomic spin happens to be for a given atom, we would pass that atom through a Stern-Gerlach apparatus, and the beam in which it emerges will tell us what the value is of this component. This relationship between preparation and measurement is of course not purely classical, but it acquires a heightened level of significance in quantum mechanics.

6.4.2 Repeated spin measurements

The Stern-Gerlach device presents a possible way of both preparing and measuring the various components of atomic spin. Thus, if a silver atom emerges in the $S_z = \frac{1}{2}\hbar$ beam, then the statement can be made that an atom has been prepared such that the z component of the spin of the valence electron is $S_z = \frac{1}{2}\hbar$.

If we pass one atom through the apparatus, then, given that the effect of the oven is to completely randomize the direction of the spin of each atom in the oven, it would come as no surprise that the atom is equally likely to emerge in either the spin up or the spin down beam. This outcome has nothing much to do with quantum mechanics, it is what we would more or less expect on the basis of classical physics, apart from the fact, of course, that quantum mechanically, any spin has only two values.

Now suppose that the atom exits in the $S_z = \frac{1}{2}\hbar$ beam. We now know the S_z component of the total spin of that atom, i.e. we have *prepared* an atom whose spin component has the value $S_z = \frac{1}{2}\hbar$. If we then immediately pass this atom into a second Stern-Gerlach apparatus with its magnetic field in the z direction, we find that the atom re-emerges in the $S_z = \frac{1}{2}\hbar$ beam, i.e. this second measurement merely confirms the first result.

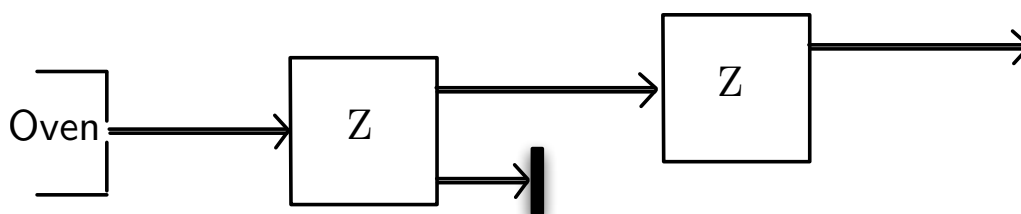

6.4.3 Quantum randomness

One of the features of quantum mechanics is that it is not possible, even in principle, to have complete knowledge of all the physical variables that characterize the state of a system. Thus, for instance, exact knowledge of the position of a particle means that there is total uncertainty in the knowledge of its momentum, and vice versa. The same is true for particle spin, except that here it is the various components of spin that cannot be known simultaneously with complete accuracy.

That this is the case has been built into quantum mechanics in a fundamental way, but the manner in which it expresses itself varies depending on the circumstances under which an attempt is made to measure more than one component of spin. It is found, in the example to be discussed below, that the uncertainty principle plays a fundamental role in that it appears to provide a mechanism, or at least an explanation, as to why only one component can be known exactly at any one time. But the real ‘why’ is that it is a fundamental law of nature.

Consider a series of spin measurements using a sequence of Stern-Gerlach devices, as illustrated in following diagram:

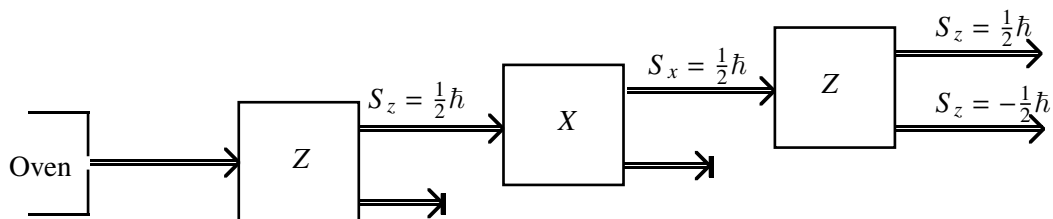

In this experiment, atoms are separated in the first device according to their z component of spin. Those for which $S_z = \frac{1}{2}\hbar$ are then passed through a second device in which atoms are separated according to their x component of spin. Those for which $S_x = \frac{1}{2}\hbar$ are passed through a third device which separates the atoms according to their z component, once again. The naive expectation is that, since these atoms have already been preselected to have $S_z = \frac{1}{2}\hbar$, then they will all emerge from the final device in the $S_z = \frac{1}{2}\hbar$ beam. It turns out that this is not what is observed. The atoms emerge randomly in either beam, but with equal probability. The interpretation that immediately comes to mind is that the intervening measurement of the x component of spin has in some way scrambled the z component of spin, but according to classical physics, it should be possible either to arrange the experiment such that any such scrambling be made negligibly small, or else be able to correct for the apparent scrambling in some fashion. It turns out that the quantum effects prevent this from happening – this scrambling, and the consequent introduction of randomness into the outcome of the experiment cannot be avoided, except at the cost of not being able to measure the x component of spin at all! Thus we see again an example of intrinsic randomness in the behaviour of macroscopic systems.

In the following section, an argument is presented which shows how it is that quantum effects prevent the simultaneous exact measurement of both the x and the z components of spin i.e. that it is uncontrollable quantum effects that give rise to the scrambling of the z component of spin during the measurement of the x component.

Incompatible Measurements of Spin Components

The obvious question to ask is whether or not the experiment can be refined in some way to avoid this scrambling. From the perspective of classical physics, the answer is definitely yes, at least in principle. The problem is that the atoms, as they pass through the second Stern-Gerlach device, will experience precession about the x axis which will have the effect of changing the z component of the spin. But by suitable fiddling with the beam, the magnetic field strengths and so on it should be possible in principle, at least from the point of view of classical physics, to minimize this effect, or at least determine exactly how much precession occurs, and take account of it. But in practice, it turns out that all these attempts fail. If the experiment is refined in such a manner that the precession is made negligible, (e.g. by using faster atoms, or a weaker magnetic field), the result is that the two emerging beams overlap so much that it is impossible to tell which beam an atom belongs to, i.e. we retain exact information on the z component of spin, but learn nothing about the

x component! In general, it appears that it is not possible to measure both S_z and S_x (or, indeed any pair of components of the particle spin), precisely. This kind of behaviour is reminiscent of what is found to happen when we attempt to measure both the position and the momentum of a particle. According to the uncertainty principle, the more precisely we determine the position of a particle, the less we know about the momentum of the particle. The difference here is that the quantities being measured are discrete – they have only two possible values, whereas the position and momentum of a free particle (even in quantum mechanics) can assume a continuous range of values.

A Detailed Analysis By use of a hybrid mixture of classical and quantum mechanical arguments, it is possible to come to some ‘understanding’ of why this occurs. Consider the atoms that have left the first Stern-Gerlach device with $S_z = \frac{1}{2}\hbar$ and enter the next device which has a magnetic field $\mathbf{B} = B\mathbf{i}$ oriented in the x direction. This magnetic field is non-uniform, in other words B is a function of position – it could be written $B(x, y, z)$. The experimental arrangement is such that the non-uniformity is most marked in the x direction – it is this non-uniformity that is responsible for the forces acting to deflect the atoms as they move through the device. In fact, the interaction of the magnetic moment $\boldsymbol{\mu}$ of the atoms with this non-uniform magnetic field has two consequences. First, as just mentioned, the atoms feel a force in the x direction given by

$$F_x = -\mu_x \frac{\partial B}{\partial x} \quad (6.17)$$

where μ_x is the x component of the magnetic moment of the atoms. If we accept in what is otherwise a classical argument, that the values of the spin of an electron are restricted to their quantized values, then

$$\mu_x = \pm \frac{e\hbar}{2m} \quad (6.18)$$

corresponding to the two possible values of $S_x = \mp \frac{1}{2}\hbar$, and leading to the formation of two separate beams corresponding to the two values of S_x .

Second, the magnetic moment of the atoms will *precess* about the direction of the magnetic field with an angular frequency given by

$$\omega = \frac{\mu_x B}{\hbar}. \quad (6.19)$$

As a consequence of this precession, the y and z components of $\boldsymbol{\mu}$ and hence of \mathbf{S} will change with time, while the x component will remain unchanged.

This precession is one ingredient in the explanation of the ‘scrambling’ of the z component of the spin. The second ingredient is based on the fact that the atomic beam that leaves the oven, and passes through the various Stern-Gerlach devices will have a non-zero cross-section, or, in other words, atoms in the beam will, in general, pass through the magnetic field along trajectories with different values of x and hence each atom will experience different magnetic field strengths, and consequently will have different precession rates. The nett result of this is that after the atoms leave the magnetic field, the various atoms will have had their magnetic moments rotated through a range of different angles, so that there will be, in consequence, a spread in the possible values of S_z . Translated into the quantum picture, this means that S_z can, with equal probability, be observed to be $\pm \frac{1}{2}\hbar$, and hence the result that is seen in the experiment.

If we are to believe that this argument has some truth in it then it seems that the ‘scrambling’ of the z component of the atomic magnetic moment can be minimized simply by making sure that all the atoms pass along the same trajectory through the magnetic fields. If this were possible, and classical physics claims that it is, then the effect of precession on the z component of spin would be the same for every atom, and so could be accounted for. The net result is that, in effect, the measurement of the x component of spin will not interfere with the results of the preceding

measurement of the z component. However, quantum mechanics, in the form of the uncertainty principle, prevents this from happening, as the following argument shows.

The fact that the atomic beam has a finite width means that there is uncertainty in the cross-sectional position of the atoms in the beam. In the x direction, the uncertainty in position is Δx , which implies, by the uncertainty principle, that there is an uncertainty Δp_x in the x component of the momentum of the atom given by

$$\Delta p_x \approx \frac{\hbar}{\Delta x}. \quad (6.20)$$

This translates into an uncertainty in the x velocity of the atom given by

$$v_x \approx \frac{\hbar}{m\Delta x}. \quad (6.21)$$

As a consequence, during the time of flight t of the atoms through the device, the uncertainty in the width of the beam will grow by an amount δx given by

$$\delta x = \Delta v_x t \approx \frac{\hbar}{m\Delta x} t. \quad (6.22)$$

So, the width of the beams is growing linearly in time. Meanwhile the two beams are separating at a rate determined by the force F_x given in Eq. (6.17). Assuming that this force is constant, then the separation between the beams will be, after a time t

$$2 \times \frac{1}{2} \frac{F_x}{m} t^2 = m^{-1} \mu_x \frac{\partial B}{\partial x} t^2 \quad (6.23)$$

where the factor of 2 comes from the fact that the two beams are pulling away from each other at the same rate. The crucial part of the argument is then this: the separation of the two beams must be greater than the widths of the beams otherwise the two beams will overlap, and it will be impossible to distinguish which beam a particle belongs to, in other words it will be impossible to know what the x component of the spin of the atom is. Thus, in order to be able to determine the x component of spin, we must have

$$\delta x \ll m^{-1} \mu_x \frac{\partial B}{\partial x} t^2 \quad (6.24)$$

which becomes, after substituting for δx

$$\hbar^{-1} \mu_x \Delta x \frac{\partial B}{\partial x} t \gg 1. \quad (6.25)$$

The quantity $\Delta x \partial B / \partial x$ is the variation in the strength of the magnetic field across the width of the beam as experienced by the atoms as they pass through the device. This means that the atoms will precess at rates that cover a range of values $\Delta \omega$ given by, from Eq. (6.19)

$$\Delta \omega = \frac{\mu_x}{\hbar} \Delta x \frac{\partial B}{\partial x}. \quad (6.26)$$

Substituted into the inequality Eq. (6.25), this gives

$$\Delta \omega t \gg 1. \quad (6.27)$$

In other words, the spread in the angle $\Delta \omega t$ through which the magnetic moments precess is so large that the z component of the spin, roughly speaking, is equally likely to have any value, in other words, it is completely randomized.

This argument shows that it is not possible to measure both the z and the x components of spin, or indeed any pair of components of spin. If we have determined a value for S_z say, and we want to

then measure S_x , then, in order to make the latter measurement possible, we have to separate the beams enough that they are distinguishable. But this unavoidably results in total randomization of the value of S_z . If we arrange the experimental conditions to be such that S_z is not changed by the measurement of S_x , we find that the two beams exiting from the Stern-Gerlach device overlap to such an extent that it is not possible to say which beam an atom belongs to, i.e. we have not, in fact, measured S_x . The preceding argument is not wholly satisfactory as it is a mixture of classical and quantum concepts, and should be viewed purely as aid to understanding what is taking place. The central, quantum mechanical fact, is that the intervening measurement of the x component randomizes the previously exactly known value of S_z . It might be argued that the fault lies with the Stern-Gerlach device, and that by using some other method of measuring the components of spin, we can get around the sort of problems encountered here. Even if S_x and S_z were measured by means that have nothing whatsoever to do with the Stern-Gerlach experiment, the same result would be obtained: an intervening measurement of the x component will randomize the previously exactly known value of S_z . A different argument based on the uncertainty relation could undoubtedly be formulated in each case to ‘explain’ the result, as discussed in Chapter 4, but the fact that the same kind of behaviour is always observed irrespective of the circumstances is telling us that there is a basic physical principle in action here, in effect a law of nature – one of the laws of quantum mechanics – that guarantees that under no circumstances is it possible to have exact knowledge of more than one component of the spin of a particle.

6.4.4 Probabilities for Spin

A crucial feature of the above result was that the intervening measurement of the x component of spin had the effect of randomizing the outcome of the remeasurement of the z component. By symmetry it is expected that if the z component of spin has been measured as $S_z = \frac{1}{2}\hbar$ say, then in the following measurement of S_x , there is an equal chance of the atoms emerging in either of the $S_x = \pm\frac{1}{2}\hbar$ beams. However, for later purposes, it is useful to have on hand an expression for the probabilities in the case in which the magnetic fields in the Stern-Gerlach devices are set in some arbitrary direction in the XZ plane (the atoms are travelling in the direction of the positive Y axis). It is possible to use arguments based on symmetry and geometry to arrive at the required results, but here, the result will be simply presented as something that can be measured.

To begin with, we will look at the following Stern-Gerlach experiment, illustrated in Fig. (6.4).

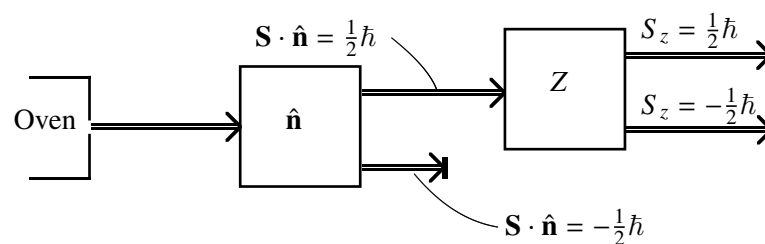

Figure 6.4: Atoms with random spin orientation filtered through a Stern-Gerlach device with magnetic field in \hat{n} direction, and the $S_i = \mathbf{S} \cdot \hat{n} = \frac{1}{2}\hbar$ beam passed through a second device with magnetic field in z direction.

In this experiment, the atoms, after they leave the oven, pass through a Stern-Gerlach device in which the magnetic field is oriented in the direction specified by the unit vector $\hat{\mathbf{n}}$, where $\hat{\mathbf{n}}$ lies in the XZ plane, at an angle of θ_i to the Z axis, see Fig. (6.5). Atoms will leave this device in one of two beams, corresponding to the component of spin \mathbf{S} in the direction of $\hat{\mathbf{n}}$ having one or the other of the two values $S_i = \mathbf{S} \cdot \hat{\mathbf{n}} = \pm \frac{1}{2}\hbar$. For the purposes of the experiment, atoms exiting from the lower beam, for which $S_i = -\frac{1}{2}\hbar$ are blocked, while those exiting in the upper beam, for which $S_i = \frac{1}{2}\hbar$ pass through a second Stern-Gerlach device, this time with its magnetic field oriented to separate the atoms according to their z component of spin. In general, the atoms will exit from this second device, once again, in one or the other of two beams, the upper one in the diagram being the beam for which $S_z = \frac{1}{2}\hbar$, the lower one being the one for which $S_z = -\frac{1}{2}\hbar$.

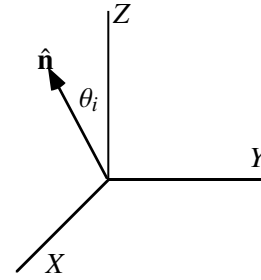

Figure 6.5: The unit vector $\hat{\mathbf{n}}$ specifies the direction of the magnetic field in a Stern-Gerlach device. This vector lies in the XZ plane, and the atomic beam travels in the direction of the positive Y axis.

Let us suppose that the experiment is repeated many times over for each setting of the angle θ_i in order to obtain, experimentally, the fraction, or in other words, the probability, of atoms emerging from the final Stern-Gerlach device in either of the two beams. The experimental result obtained is that

$$\begin{aligned} \text{Probability of atoms emerging in the } S_z = \frac{1}{2}\hbar \text{ beam} &= \cos^2(\theta_i/2) \\ \text{Probability of atoms emerging in the } S_z = -\frac{1}{2}\hbar \text{ beam} &= \sin^2(\theta_i/2) \end{aligned} \quad (6.28)$$

At this point it is useful to introduce a new notation for this probability. First we note that the atoms, as they exit from the first Stern-Gerlach device, are such that $S_i = \frac{1}{2}\hbar$. Next we note that this is the maximum amount of information that we can have about the spin of these atoms – any attempt to measure another component will scramble this component in an uncontrollable way. So, to the best that we can manage, we can characterize the physical state of the atoms by $S_i = \frac{1}{2}\hbar$. When they exit from the second Stern-Gerlach device, they are either in a state for which $S_z = \frac{1}{2}\hbar$, or for which $S_z = -\frac{1}{2}\hbar$. We will now adopt the notation

$$P(A|B) = \text{Probability of observing a system in a state for which information } A \text{ is known given that it was in a state for which information } B \text{ is known.}$$

We can now write

$$\begin{aligned} P(S_z = \frac{1}{2}\hbar | S_i = \frac{1}{2}\hbar) &= \cos^2(\theta_i/2) \\ P(S_z = -\frac{1}{2}\hbar | S_i = \frac{1}{2}\hbar) &= \sin^2(\theta_i/2) \end{aligned} \quad (6.29)$$

We can check to see if this makes physical sense by looking at some special cases. Thus, if $\hat{\mathbf{n}} = \hat{\mathbf{k}}$, i.e. the first Stern-Gerlach device has the magnetic field oriented in the z direction, then $S_i = S_z$ and $\theta_i = 0$ so that the device is equivalent to the set-up given in Fig. (6.6)

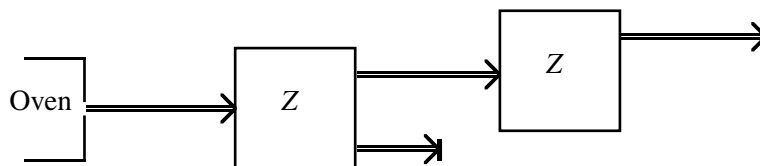

Figure 6.6: Same as Fig. (6.4) but with $\hat{\mathbf{n}}$ in z direction.

and the probabilities become, from Eq. (6.28) with $\theta_i = 0$

$$\begin{aligned} P(S_z = \frac{1}{2}\hbar | S_z = \frac{1}{2}\hbar) &= 1 \\ P(S_z = -\frac{1}{2}\hbar | S_z = \frac{1}{2}\hbar) &= 0 \end{aligned} \quad (6.30)$$

which is as it should be – if an atom has been measured to have $S_z = \frac{1}{2}\hbar$, then a subsequent measurement of S_z should simply confirm this result.

Next, if we look at the case of $\hat{\mathbf{n}} = \hat{\mathbf{i}}$, so that the magnetic field is oriented in the x direction in the first Stern-Gerlach device, then we have $S_i = S_x$ and $\theta_i = \pi/2$. The set-up is then as illustrated in Fig. (6.7)

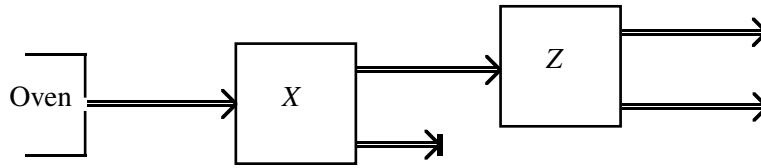

Figure 6.7: Same as Fig. (6.4) but with $\hat{\mathbf{n}}$ in x direction.

and the probabilities are, from Eq. (6.28) with $\theta_i = \pi/2$

$$\begin{aligned} P(S_z = \frac{1}{2}\hbar | S_x = \frac{1}{2}\hbar) &= \frac{1}{2} \\ P(S_z = -\frac{1}{2}\hbar | S_x = \frac{1}{2}\hbar) &= \frac{1}{2} \end{aligned} \quad (6.31)$$

which is also consistent with what we have seen before – if the atom has been measured to have $S_x = \frac{1}{2}\hbar$, then there is an equal chance that it will be measured to have $S_z = \pm\frac{1}{2}\hbar$. Finally, we will consider the case in which $\hat{\mathbf{n}} = -\hat{\mathbf{k}}$, i.e. $\theta_i = \pi$. In this case, $S_i = -\mathbf{S} \cdot \hat{\mathbf{k}} = -S_z$ and the set-up is as in Fig. (6.8).

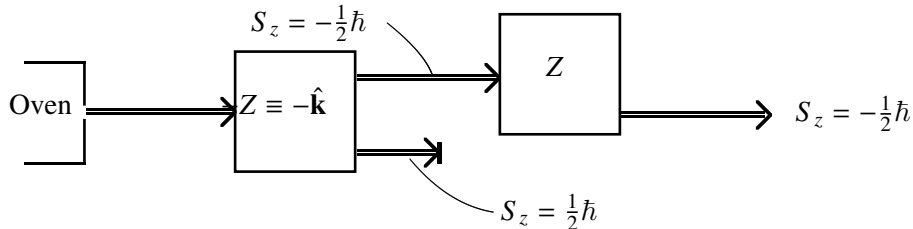

Figure 6.8: Atoms with random spin orientation filtered through a Stern-Gerlach device with magnetic field in $\hat{\mathbf{n}} = -\hat{\mathbf{k}}$ direction. The atoms in the upper beam exiting from this Stern-Gerlach device are those for which $S_i = \mathbf{S} \cdot \hat{\mathbf{n}} = -S_z = \frac{1}{2}\hbar$.

As the field is in the negative z direction, the upper beam leaving the first Stern-Gerlach device in Fig. (6.8) will have $S_i = -S_z = \frac{1}{2}\hbar$, i.e. $S_z = -\frac{1}{2}\hbar$. Consequently, when this beam enters the next Stern-Gerlach device with the field oriented in the z direction, all the atoms will emerge in the $S_z = -\frac{1}{2}\hbar$ beam. This is in agreement with the probabilities that follow from Eq. (6.28) with $\theta_i = \pi$, i.e.

$$\begin{aligned} P(S_z = \frac{1}{2}\hbar | S_z = -\frac{1}{2}\hbar) &= \cos^2(\frac{1}{2}\pi) = 0 \\ P(S_z = -\frac{1}{2}\hbar | S_z = -\frac{1}{2}\hbar) &= \sin^2(\frac{1}{2}\pi) = 1 \end{aligned} \quad (6.32)$$

6.5 Quantum Interference for Spin

In the last Chapter, what is identified as the essential ‘mystery’ of quantum mechanics was illustrated in the two slit experiment using particles. In this experiment, there are two ways that a particle can pass from the particle source to the observation screen i.e. via one slit or the other, but provided the slit through which the particle passes is *not* observed, the particles do not strike the screen in a way that is consistent with our intuitive notion of the way a particle should behave: the particles strike the observation screen at random, but with a preference to accumulate in certain regions, and not at all in other regions, so as to form a pattern identical to the interference pattern that would be associated with waves passing through the slits. In contrast, if the slit through which each particle passes is observed in some fashion, the interference pattern is replaced by the expected result for particles. It is the lack of any explanation for this kind of behaviour in terms of everyday intuition and/or classical physics that is seen as the fundamental mystery of quantum mechanics.

It was inferred from this experiment that associated with the particle was some kind of wave, a probability amplitude wave or wave function which, for a point x on the observation screen, could be written as the sum of two contributions originating from each slit – $\Psi(x, t) = \Psi_1(x, t) + \Psi_2(x, t)$ – and whose intensity $|\Psi(x, t)|^2$ gave the probability density of observing a particle at a particular position x on the observation screen. All these results referred to the measurement of the position of the particle, a continuously variable quantity. The aim here is to show that interference is a signature of quantum mechanics even when, as in the case of particle spin, the property of the particle being observed is not its position, but rather its spin, which can only have discrete values. Moreover, it is intended to show that interference arises when there is more than one ‘path’ that a particle can follow between its source and its final observation. This demonstration provides further evidence that there is an underlying commonality between different examples of quantum behaviour, evidence of some fundamental law or laws that apply to all physical systems, though superficially realized in different ways for different systems. In this experiment, atoms emerge from the oven, and are then passed through a Stern-Gerlach device whose magnetic field is oriented so as to separate the atoms into two beams according to their x component of spin. The atoms emerge in two separate beams corresponding to the atomic spin component $S_x = \mathbf{S} \cdot \hat{\mathbf{i}} = \pm \frac{1}{2} \hbar$. The atoms in one of the beams ($S_x = \frac{1}{2} \hbar$) is then selected and passed through a Stern-Gerlach device where the magnetic field further separates this beam according to its z component of spin. The atoms emerge in one or the other of two beams corresponding to $S_z = \mathbf{S} \cdot \hat{\mathbf{k}} = \pm \frac{1}{2} \hbar$. The two beams are then recombined into a single beam. This is done using a third Stern-Gerlach device in which the magnetic field is equal and opposite to the preceding device. This does not scramble the spins of the atoms – the sole purpose is to recombine the beams and could equally well have been done by some other technique. Finally, this beam is passed through a further Stern-Gerlach device with its magnetic field oriented in the x direction so that atoms will emerge from this device with either $S_x = \pm \frac{1}{2} \hbar$.

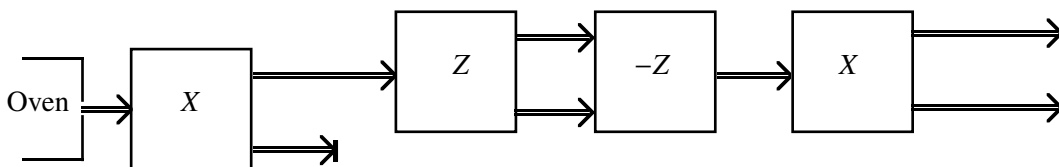

Figure 6.9: Atomic beam for which $S_x = \frac{1}{2} \hbar$ split into $S_z = \pm \frac{1}{2} \hbar$ beams and then recombined before passing through a final Stern-Gerlach device with magnetic field in x direction.

It is important to see the analogy between this setup and the two slit interference experiment. The

oven plus the first Stern-Gerlach device is the equivalent of the source of identically prepared particles in the two slit experiment. Here the atoms are all identically prepared to have $S_x = \frac{1}{2}\hbar$. The next two Stern-Gerlach devices are analogous to the two slits in that the atoms can, in principle, follow two different paths corresponding to $S_z = \pm\frac{1}{2}\hbar$ before they are recombined to emerge in one beam. The analogue is, of course, with a particle passing through one or the other of two slits before the position where it strikes the observation screen is observed. We can tell which path an atom follows (i.e. via the $S_z = \frac{1}{2}\hbar$ or the $S_z = -\frac{1}{2}\hbar$ beam) by monitoring which beam an atom emerges from after it passes through the first z oriented Stern-Gerlach device in much the same way that we can monitor which slit a particle passes through in the two slit experiment. Watching to see in which beam an atom finally emerges after passing through the last Stern-Gerlach device is then analogous to seeing where on the observation screen a particle lands after passing through the two slit device.

The results found are as follows. If the intervening state of the atoms is *not* observed, the results obtained are the same as if the beam splitter-recombiner were not there, i.e. the results are the same as in Fig. (6.6), and Eq. (6.30), though here for the x component. However, if the z component of the spin *is* observed, then it is effectively an atom with a known z component of spin that enters the last Stern-Gerlach device, as for Fig. (6.7), and hence the probability of the atom having either value of S_x becomes $\frac{1}{2}$, as in Eq. (6.31).

This behaviour is reminiscent of what was observed in the two slit experiment – if we do not observe through which slit the particles pass, then we observe an interference pattern. If we do observe through which slit the particles pass, then there is no interference pattern. So, is there a sense in which the results found above for the Stern-Gerlach experiment can be interpreted as the presence of interference in the first case, and no interference in the second? We can present a persuasive, but non-rigorous argument that this is the case. A much sharper argument is presented later in Section 7.3.

Suppose, for the present that probability amplitudes can indeed be associated with the atoms passing through either of the two $S_z = \pm\frac{1}{2}\hbar$ beams before their x component of spin is observed. So let $\Psi_{\pm}(S_x)$ be the amplitudes for the spin to be measured to be S_x , given that they passed through either the $S_z = \frac{1}{2}\hbar$ or the $S_z = -\frac{1}{2}\hbar$ beam. This is analogous to the probability amplitudes $\Psi_n(x)$ of observing the particle at position x given that they passed through slit n . From the results presented above if we do not observe through which intervening beam the atoms passed, we should add the probability amplitudes and then take the square:

$$\begin{aligned} \text{Probability of atom emerging in} \\ S_x = \frac{1}{2}\hbar \text{ beam} \end{aligned} &= |\Psi_+(\frac{1}{2}\hbar) + \Psi_-(\frac{1}{2}\hbar)|^2 = 1 \tag{6.33}$$

$$\begin{aligned} \text{Probability of atom emerging in} \\ S_x = -\frac{1}{2}\hbar \text{ beam} \end{aligned} &= |\Psi_+(-\frac{1}{2}\hbar) + \Psi_-(-\frac{1}{2}\hbar)|^2 = 0$$

While, if we *do* observe through which beam they pass, we should add the probabilities:

$$\begin{aligned} \text{Probability of atom emerging in} \\ S_x = \frac{1}{2}\hbar \text{ beam} \end{aligned} &= |\Psi_+(\frac{1}{2}\hbar)|^2 + |\Psi_-(\frac{1}{2}\hbar)|^2 = \frac{1}{2} \tag{6.34}$$

$$\begin{aligned} \text{Probability of atom emerging in} \\ S_x = -\frac{1}{2}\hbar \text{ beam} \end{aligned} &= |\Psi_+(-\frac{1}{2}\hbar)|^2 + |\Psi_-(-\frac{1}{2}\hbar)|^2 = \frac{1}{2}.$$

By symmetry we should also have that

$$|\Psi_{\pm}(\frac{1}{2}\hbar)|^2 = |\Psi_{\pm}(-\frac{1}{2}\hbar)|^2 \tag{6.35}$$

i.e. whether the atom comes through via the $S_z = \frac{1}{2}\hbar$ or the $S_z = -\frac{1}{2}\hbar$ beams, they should still have an equal chance of emerging in either of the $S_x = \pm\frac{1}{2}\hbar$ beams. A quick calculation shows

that these equations are satisfied by

$$\Psi_{\pm}(\frac{1}{2}\hbar) = \frac{1}{2} \quad \Psi_{\pm}(-\frac{1}{2}\hbar) = \pm\frac{1}{2}. \quad (6.36)$$

In other words, the possibility exists of interpreting the observed results as being the consequence of interference taking place. Thus, we have

$$\begin{aligned} \text{Probability of atom emerging in} \\ S_x = \pm\frac{1}{2}\hbar \text{ beam} \end{aligned} = |\frac{1}{2} \pm \frac{1}{2}|^2 = \frac{1}{4} + \frac{1}{4} \pm \frac{1}{2} \quad (6.37)$$

where the term $\pm\frac{1}{2}$ is the ‘interference’ term. We have constructive interference when this term is positive, giving unit probability of finding the atom exiting in the $S_x = \frac{1}{2}\hbar$ beam, and destructive interference when this term is negative, giving zero probability of the atom emerging in the $S_x = -\frac{1}{2}\hbar$ beam. If the intervening beam through which the atoms pass is observed, the results are just a half for either the $S_x = \frac{1}{2}\hbar$ or the $S_x = -\frac{1}{2}\hbar$ beam, which is just the result that is obtained if the interference term in Eq. (6.37) is removed. Thus, there indeed appear to be two contributions to the total probability amplitude of observing the atom to have the x component of spin equal to $\pm\frac{1}{2}\hbar$, these being associated with the probability amplitudes of the atoms passing along one or the other of the two S_z beams.

There is a complete analogue here with the two slit experiment. In that experiment, the aim was to provide two paths along which the particles could pass: from the source through either slit 1 or 2, and then to the final measurement of the x position on the screen. Here, we want to provide two possible ‘paths’ for the *spin* of the atoms: from initial spin $S = \frac{1}{2}\hbar$, through either of $S_z = \frac{1}{2}\hbar$ or $S_z = -\frac{1}{2}\hbar$, until finally a measurement is made of S_x . The spin of the atoms therefore follows paths in what might be called ‘spin space’, rather than in real space. Experimentally these paths in spin space are produced by providing different paths in real space for the atoms to follow, depending on their spin, but this is a feature of the experiment only, and largely irrelevant to the argument being developed here.

The first Stern-Gerlach device plays the same role here as the source of particles in the two-slit experiment, and provides a source of atoms for which $S_x = \frac{1}{2}\hbar$. The Stern-Gerlach device that separates the beams in the z direction is then the equivalent of the two slits as it provides two different ‘paths’ that the atomic spin can follow prior to the final measurement. By then recombining the two beams, we lose all information concerning the path that the atoms follow. Thus, when the final measurement of the x component of spin is performed, we have no way of knowing whether an atom exited from the second Stern-Gerlach device with $S_z = \frac{1}{2}\hbar$ or $S_z = -\frac{1}{2}\hbar$, unless we explicitly observe which beam an atom belongs to immediately as it exits the device. This is analogous to not knowing which slit a particle passes through before its x position is measured on the observation screen in the usual two slit experiment.

We therefore find, once again, that if we have information on which ‘path’ the system of interest follows as it makes its way from some initial state to some final measurement, we get a different result from what we get if we do not have this information. In the case of the two slit experiment, lack of ‘which path’ information leads to wave-like interference effects which are absent if we do know which slit the particle passes through. In the case of particle spin the result obtained when the intermediate spin S_z is not observed can also be interpreted as being due to interference effects which are absent if the spin of the atoms is observed. For the present it is sufficient to note that the outcome of the experiment does depend on whether or not the intermediate observation of S_z is made. It therefore appears that there is much in common between the two slit experiment and the spin experiment, in spite of the manifestly different physical character of the experiments. Put in another way, there appears to be some fundamental laws in action here, the laws of quantum mechanics, that are expressed in slightly different ways in different physical systems: interference and randomness observed in the measurement of particle position in the two slit experiment, and

similar behaviour in the measurement of particle spin. The laws of quantum mechanics, and the mathematical language in terms of which these laws are stated, is the subject of the following Chapter.